



EGLO
my light | my style

2023/24

OUTDOOR LUMINAIRES

AUSSENLEUCHTEN
LUMINAIRES EXTÉRIEURS



Dear business partners and loyal EGLO friends,

We offer the perfect lighting for your garden, terrace or balcony. Our selection of exterior lights ranges from classic models to modern, minimalist, and even extravagant designs. We have also embraced the outdoor living trend and created an extensive garden living range.

Exterior lights are not only aesthetically appealing – they provide essential security for your home too, particularly during dark autumn evenings and winter months. The lights in our Safety & Comfort range, all of which feature motion sensors, are ideal for this purpose.

Our connect.z smart light system makes operating your lighting system easy and convenient from your mobile or by remote control. We offer a range of products that allows you to stay connected even in the garden.

In response to the current demand for sustainability, energy conservation and responsible use of resources, we have also expanded our selection of exterior lights to include our first high-illumination solar models.

We hope you enjoy browsing our catalogue!

Geschätzte Geschäftspartner*innen, treue EGLO Freund*innen,

Wir bieten Ihnen die perfekte Beleuchtung für Ihren Garten, Ihre Terrasse oder Ihren Balkon. Unser Sortiment an Außenleuchten reicht von klassischen Modellen bis hin zu modernen, minimalistischen und auch extravaganen Designs. Zudem haben wir die Trends „Wohnen im Außenbereich“ aufgegriffen und ein umfangreiches Garden Living Sortiment erstellt.

Außenleuchten sind aber nicht nur aus ästhetischen Gründen sinnvoll, sondern sorgen vor allem in den dunklen Herbsttagen und Wintermonaten für die nötige Sicherheit rund um Ihr Zuhause. Das gelingt mit unseren Leuchten aus dem Bereich Safety & Comfort, welche alle über Bewegungssensoren verfügen.

Unser Smart Light System connect.z ermöglicht Ihnen die bequeme Bedienung Ihres Lichtsystems. Von Ihrem Mobiltelefon aus oder per Fernbedienung. Hier bieten wir eine Produktrange die Konnektivität bis in den Garten bietet.

Auf die Trends Nachhaltigkeit, Energiesparen und dem verantwortungsvollen Umgang mit Ressourcen, haben wir auch in unserem Außenleuchten Sortiment reagiert. Hier haben wir erste Solarmodelle mit hoher Lichtleistung in unserem Sortiment ergänzt.

Wir wünschen Ihnen viel Vergnügen beim Durchstöbern unseres Katalogs!

Chers partenaires commerciaux*, fidèles amis d'EGLO*,

EGLO vous propose des solutions d'éclairage parfaites pour votre jardin, votre terrasse ou votre balcon. Notre gamme de luminaires d'extérieur va du classique au moderne, en passant par le minimaliste et l'extravagant. Par ailleurs, en nous appuyant sur le concept « Vivre à l'extérieur », nous avons créé toute une gamme Garden Living.

En plus d'être esthétiques, les luminaires extérieurs assurent également la sécurité dont vous avez besoin autour de votre maison, surtout pendant les sombres journées d'automne et les mois d'hiver. C'est le cas de nos luminaires de la gamme Safety & Comfort, qui disposent tous de capteurs de mouvement.











Notre système Smart Light Bluetooth connect.z vous permet de commander facilement votre système d'éclairage à partir de votre téléphone portable ou d'une télécommande.

Nous vous souhaitons beaucoup de plaisir à parcourir notre catalogue !



CONTENT

INHALT
CONTENU

- 4**  **High IP Class**
Hohe IP Klasse
Classe IP élevée
- 8**  **Safety & Comfort**
Sicherheit und Komfort
Sécurité & confort
- 14**  **EGLO connect.z**
EGLO connect.z
EGLO connect.z
- 36**  **Modern**
Modern
Moderne
- 82**  **Timeless**
Zeitlos
Intemporel
- 140**  **Traditional**
Traditionell
Traditionnel
- 180**  **Functional**
Funktionell
Fonctionnel
- 210**  **Garden Living**
Garten Leben
Vie au jardin
- 234**  **Solar**
Solar
Solaire
- 254**  **Legend & Register**
Legende und Register
Légende & registre

Best protection against wind and weather

Bester Schutz vor Wind und Wetter
Meilleure protection contre le vent et les intempéries



EGLO's High IP class product range includes all luminaires with a particularly high degree of protection. These are best suited for harsh environments such as sandy or coastal regions.

All EGLO outdoor lights are basically secured with at least a degree of protection of IP44! For higher degrees, the degree of protection is indicated in the info box of the lights.

EGLOs High IP class Produktsortiment umfasst alle Leuchten mit einem besonders hohen Schutzgrad. Diese sind bestens geeignet für raue Umgebungen wie beispielsweise sandige oder küstennahe Regionen.

Alle EGLO Außenleuchten sind grundsätzlich mit mindestens einem Schutzgrad von IP44 gesichert! Bei höheren Graden wird der Schutzgrad im Infokasten der Leuchten angegeben.

La gamme de produits EGLO de classe IP élevée comprend tous les luminaires présentant un degré de protection particulièrement élevé. Ils sont parfaitement adaptés aux environnements difficiles tels que les régions sablonneuses ou côtières.

Toutes les lampes d'extérieur EGLO sont toujours protégées avec un degré de protection d'au moins IP44 ! Pour les degrés supérieurs, le degré de protection est indiqué dans la boîte d'information des feux.

SOLIDS / FESTSTOFFE / SOLIDES

0	Non protected. Nicht geschützt. Non protégé.
1	Protected against a solid object greater than 50mm, such as a hand. Geschützt gegen feste Gegenstände, die größer als 50 mm sind, wie z. B. eine Hand. Protégé contre un objet solide de plus de 50 mm, comme une main.
2	Protected against a solid object greater than 12mm, such as a finger. Geschützt gegen feste Gegenstände, die größer als 12 mm sind, wie z. B. einen Finger. Protégé contre un objet solide de plus de 12 mm, tel qu'un doigt.
3	Protected against a solid object greater than 2,5mm, such as a screw driver. Geschützt gegen feste Gegenstände, die größer als 2,5 mm sind, z. B. einen Schraubendreher. Protégé contre un objet solide supérieur à 2,5 mm, tel qu'un tournevis.
4	Protected against a solid object greater than 1mm, such as a screw or wire. Geschützt gegen feste Gegenstände, die größer als 1 mm sind, wie z. B. Schrauben oder Drähte. Protégé contre un objet solide de plus de 1 mm, tel qu'une vis ou un fil.
5	Dust protected. Prevents ingress of dust sufficient to cause harm. Staubgeschützt. Verhindert das Eindringen von Staub, der ausreicht, um Schäden zu verursachen. Protégé contre la poussière. Empêche la pénétration de poussière suffisamment pour causer des dommages.
6	Dust tight. No ingress of dust. Staubdicht. Kein Eindringen von Staub. Étanche à la poussière. Pas de pénétration de poussière.

WATER / WASSER / L'EAU

0	Non protected. Nicht geschützt. Non protégé.
1	Protected against vertical dripping water. Limited liquid entry. Geschützt gegen senkrechtetes Tropfwasser. Eingeschränkter Flüssigkeitseintrag. Protégé contre les gouttes d'eau verticales. Entrée de liquide limitée.
2	Protected against vertical dripping water when tiled up 15°. Limited liquid entry. Geschützt gegen senkrechtetes Tropfwasser bei Verfliesung 15°. Eingeschränkter Flüssigkeitseintrag. Protégé contre les gouttes d'eau verticales lorsqu'il est carrelé jusqu'à 15°. Entrée de liquide limitée.
3	Protected against vertical spraying water at an angle up to 68°. Limited liquid entry. Geschützt gegen senkrechtetes Spritzwasser in einem Winkel bis 68°. Eingeschränkter Flüssigkeitseintrag. Protégé contre les projections d'eau verticales à un angle allant jusqu'à 68°. Entrée de liquide limitée.
4	Protected against vertical splashing water at an angle up to 60°. Limited liquid entry. Geschützt gegen senkrechtetes Spritzwasser in einem Winkel bis 60°. Eingeschränkter Flüssigkeitseintrag. Protégé contre les projections d'eau verticales à un angle allant jusqu'à 60°. Entrée de liquide limitée.
5	Protected against jets of water from all directions. Limited liquid entry. Geschützt gegen Strahlwasser aus allen Richtungen. Eingeschränkter Flüssigkeitseintrag. Protégé contre les jets d'eau de toutes directions. Entrée de liquide limitée.
6	Protected against powerful jets of water from all directions. Limited liquid entry. Geschützt gegen starke Wasserstrahlen aus allen Richtungen. Eingeschränkter Flüssigkeitseintrag. Protégé contre les jets d'eau puissants de toutes les directions. Entrée de liquide limitée.
7	Protected against the effects of water immersion between 15cm and 1m. Geschützt gegen die Auswirkungen von Wassereintauchen zwischen 15 cm und 1 m. Protégé contre les effets d'une immersion dans l'eau entre 15cm et 1m.
8	Protected against the effects of water immersion under pressure beyond 1m. Geschützt gegen die Auswirkungen des Eintauchens in Wasser unter Druck über 1 m. Protégé contre les effets de l'immersion dans l'eau sous pression au-delà de 1m.

IP65

For more detailed information see DIN EN 60529.
Für genauere Informationen siehe DIN EN 60529.
Pour des informations plus détaillées, voir DIN EN 60529.

HIGH IP CLASS

Chapter / Kapitel / Chapitre **connect.z**



Chapter / Kapitel / Chapitre **Modern**



Chapter / Kapitel / Chapitre **Timeless**



Chapter / Kapitel / Chapitre TRADITIONAL



IP55

CANOVE

152

Chapter / Kapitel / Chapitre Functional



IP65

FAEDO 4

184



IP54

NEMA

185



IP65

FAEDO 3

186-187, 190-191



IP 65/67

LAMEDO

198



IP67

RIGA 3

198



IP 65/67

TRONTO

199



IP65

ZIMBA-LED

201



IP 65/20

MARGO

201



IP68

CONNECTOR BOX

205



IP54

PARK5

206

Chapter / Kapitel / Chapitre Garden Living



IP54

PICCOLA

213



IP54

MEGGIANO

217



IP54

MANNERA

218-219



IP65

FOSSOMBRONE

220



IP65

BOTTONA,
MONTEROLO

222, 224-225



IP65

SPINETOLI 2

231

Chapter / Kapitel / Chapitre Solar



IP54

LAMOZZO

250



This product is available in different colors and shapes. /
Dieser Artikel ist in unterschiedlichen Farben und Formen verfügbar.
Cet article est disponible en différentes couleurs et formes.

SAFETY & COMFORT





SAFETY & COMFORT



Light at the right time

Light activated by movements offers many advantages. EGLO sensor luminaires and sensors provide you with a great deal of comfort in your daily life and increase the safety of your own four walls.

Licht zum richtigen Zeitpunkt

Licht, das durch Bewegungen aktiviert wird, bietet Ihnen viele Vorteile. Mit den Sensorleuchten und Sensoren von EGLO bringen Sie erheblichen Komfort in Ihren Alltag und erhöhen die Sicherheit rund um Ihr Zuhause.

Lumière au bon moment

Lumière, qui est activé par le mouvement, offre de nombreux avantages. Avec les lumières des capteurs et des capteurs de EGLO apporter un confort considérable dans votre vie quotidienne et d'augmenter la sécurité de vos propres quatre murs.



1. COMFORT



2. SAFETY



3. SECURITY



4. SAVE MONEY

1. COMFORT

The light comes on – without requiring you to push a button, leaving your hands free to carry your shopping bags. Come home comfortably with the sensors and sensor lamps by EGLO.

2. SAFETY

EGLO sensors and sensor lamps will show you thresholds and tripping hazards in time. Lower your accident risk in and around your home.

3. SECURITY

Motion detection will safely light up badly visible areas when this is necessary. You will always be able to see what is happening and can deter unbidden guests with the EGLO sensors and sensor lamps.

4. SAVE MONEY

Sensors and sensor lamps by EGLO help you save money. Your light will only come on when it is needed, and lower the energy costs for every home.

1. KOMFORT

Das Licht geht an – ohne dass Sie einen Schalter drücken müssen und Sie haben die Hände frei, um die Einkäufe zu tragen. Kommen Sie komfortabel nach Hause mit den Sensoren und Sensorleuchten von EGLO.

2. SICHERHEIT

EGLO Sensoren und Sensorleuchten lassen Sie Schwellen und Stolperfallen vorzeitig erkennen. Senken Sie dadurch das Unfallrisiko in und um Ihr Zuhause.

3. SCHUTZ

Durch die Erfassung von Bewegung können schlecht einsichtbare Bereiche beleuchtet werden, wenn es notwendig ist. Sehen Sie immer was passiert und schrecken Sie ungebetene Gäste mit EGLO Sensoren und Sensorleuchten ab.

4. GELD SPAREN

Sensoren und Sensorleuchten von EGLO helfen Ihnen bares Geld zu sparen. Das Licht geht nur an, wenn es benötigt wird und senkt damit die Energiekosten in Ihrem Zuhause.

1. COMFORT

La lumière s’allume – sans que vous n’ayez besoin de presser un interrupteur et vous avez les mains libres pour porter les achats. Entrez confortablement chez vous avec les capteurs et les luminaires à capteurs d’EGLO.

2. SÛRETÉ

Les capteurs et les luminaires à capteurs d’EGLO vous permettent de déceler d’avance les seuils et sources de trébuchement. Réduisez ainsi les risques d’accident dans et autour de votre foyer.

3. SÉCURITÉ

Il est possible grâce à la saisie des mouvements d’éclairer au besoin des zones difficiles à voir. Ayez toujours un œil sur ce qu’il se passe et découragez les intrus avec les capteurs et les lampes à capteur d’EGLO.

4. DE L’ARGENT EN SÉCURITÉ

Les capteurs et les lampes à capteur d’EGLO vous aident à économiser de l’argent comptant. La lumière ne vient que lorsque celle-ci est requise, ce qui réduit ainsi les dépenses énergétiques de tout foyer.

SAFETY & COMFORT

Chapter / Kapitel / Chapitre **connect.z**



CONNECT-Z SENSOR

24

Chapter / Kapitel / Chapitre **Modern**



RIFORANO

41



FIUMICINO

48



PALOSCO

50



CALDIERO

50



FORNACI

54



PERNATE

55



BELCREDA

71



SESIMBA 1

72

Chapter / Kapitel / Chapitre **Timeless**



ALAMONTE 3

86



ALAMONTE

88



HELSINKI

95-97



CORNALE

104



AZZINANO

105



MADRIZ

106



SALVANESCO

106



TRONO STICK

108



RIGA 5

114-115



ATOLLARI

116



SAKEDA

118



CASAZZA

133



MUSSOTTO

133



VERRES

133



BREGANZO 1

135



TRIBANO

136



CERNO

137



CITY

138-139

Chapter / Kapitel / Chapitre Traditional



SIDNEY

147



LISIO

148



NAVEDO

166, 168



LATERNA 4

173



LATERNA 5

174

Chapter / Kapitel / Chapitre Functional



PAGINO

182



FAEDO 3

188-189, 192-193



DETECT ME 1

194, 197



DETECT ME 6

194, 197



DETECT ME 3,
DETECT ME 5

194, 195, 197



LM_LED_E27

202

Chapter / Kapitel / Chapitre Solar



DREOLI

238



CERRISI

238



CORBEZZOLA

240



MARTANO

240



ALTILIA

242



PANTETE

245



SPIANTE

246



BARACCONI

246



UTRERA

248



CROARA

248



PASTION

248



STIAPPA

249



SUZZARA

249



LAMOZZO

250



PORRASSA

250



PALIZZI

253



VILLAGRAPPA

252



PANETTIERI

252



CASABAS

253



This product is available in different colors and shapes. / Dieser Artikel ist in unterschiedlichen Farben und Formen verfügbar.
Cet article est disponible en différentes couleurs et formes.

connect.2



zigbee



Bluetooth®

Discover the smart world



connect.z combines two control technologies in one system

connect.z vereint zwei Steuerungstechnologien in einem System

connect.z réunit deux technologies de commande au sein d'un même système



ZigBee is far and away the most widely used standard in the smart home world.
ZigBee ist der am weitesten verbreitete Standard in der Smart Home Welt.
ZigBee est le protocole le plus répandu au monde dans le domaine du Smart Home.

ADVANTAGES :

- › Mesh network
- › Direct connection with Google Home
- › Connection via Alexa with integrated or separate Zigbee hub
- › Compatible with products from different manufacturers
- › High level of security
- › Easy setup
- › Energy efficient

VORTEILE:

- › Mesh-Netzwerk
- › Direkte Verbindung mit Google Home
- › Verbindung mit Alexa mit integriertem oder separatem Zigbee Hub
- › Herstellerübergreifend kompatibel
- › Hohe Sicherheit
- › Einfache Einrichtung
- › Energieeffizient

AVANTAGES:

- › Réseau maillé
- › Connexion directe à Google Home
- › Connexion à Alexa avec un Hub Zigbee intégré ou séparé
- › Compatible indépendamment du fabricant
- › Sécurité élevée
- › Installation facile
- › Économe en énergie

connect.2



Bluetooth is an established standard in the digital world.
Bluetooth ist ein etablierter Standard in der digitalen Welt.
Bluetooth est un standard de communication reconnu dans le monde numérique.

ADVANTAGES:

- › Local & secure network
- › Protocol is mainly audio (low debit)
- › Mesh network: Elements are receivers and senders
- › Easy setup
- › Usable offline
- › Energy efficient

VORTEILE:

- › Lokales & sicheres Netzwerk Protokoll hauptsächlich Audio (Low Debit)
- › Mesh-Netzwerk: Elemente sind Empfänger und Sender
- › Einfache Einrichtung
- › Offline nutzbar
- › Energieeffizient

AVANTAGES:

- › Réseau local et sûr
- › Protocole essentiellement audio (bas débit)
- › Réseau maillé : les éléments sont l'émetteur et le récepteur
- › Installation facile
- › Utilisable hors-ligne
- › Économe en énergie

Light up your world!

Bringen Sie Licht in Ihren Alltag!
Illuminez votre quotidien !



connect.z offers a wide range of lamps and lighting equipment. Select products from the following options according to your needs:
connect.z bietet ein großes Sortiment an Leuchten und Leuchtmitteln. Wählen Sie die Produkte ganz nach Ihren Bedürfnissen aus folgenden Varianten:
connect.z propose une large gamme de luminaires et d'ampoules. Sélectionnez les produits en fonction de vos besoins parmi les variantes suivantes :

Warm White

Neutral White

Tunable White

Individual light from 50,000 white tones.
Individuelles Licht aus 50.000 Weißtönen.
Luminaire individuel à 50 000 tons de blanc.

TW + RGB Colors

Diverse lighting selection from 50,000 white tones and 16 million colours.
Vielseitige Lichtauswahl aus 50.000 Weißtönen und 16 Mio. Farben.
Sélection étendue de luminaires à 50 000 tons de blanc et 16 millions de couleurs.

Enjoy relaxing moments!
Genießen Sie entspannte Momente!
Profitez de moments de détente !

Stay focussed & efficient!
Bleiben Sie konzentriert & leistungsfähig!
Restez concentré(e) et performant(e) !

Start the day fresh every morning!
Starten Sie jeden Morgen frisch in den Tag!
Commencez la journée du bon pied !

Create the perfect atmosphere!
Kreieren Sie Ihr perfektes Ambiente!
Créez votre ambiance parfaite !



Enjoy many useful convenience features:

Es erwarten Sie viele nützliche Komfortfunktionen:
De nombreuses fonctionnalités utiles vous attendent pour votre confort :



TIMERS AND CALENDARS / TIMER UND ZEITPLÄNE/ MINUTERIE ET CALENDRIER

Make your daily life easier with timers and calendars.
Wake up relaxed with the simulated sunrise.

Unterstützen Sie Ihren Alltag mit Timern und Zeitplänen. Entwickeln Sie eigene Lichtroutinen und machen Sie Ihr Leben leichter.

Facilitez-vous la vie à l'aide de la fonction minuterie et calendrier.
Réveillez-vous en douceur grâce au simulateur de lever de soleil.

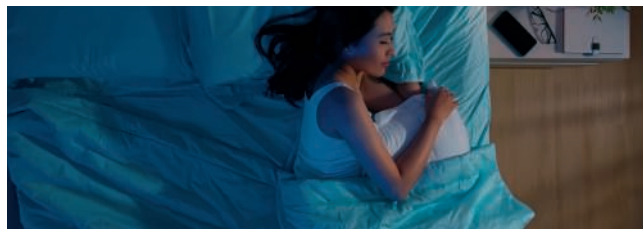

LIGHT ALARM CLOCK/ LICHTWECKER/ REVEIL LUMINEUX

You'd rather not start your day in a bad mood? Wake up relaxed with the simulated sunrise.

Keine Lust mit schlechter Laune in den Tag zu starten? Entspannt aufwachen mit dem simulierten Sonnenaufgang.

Pas envie de commencer la journée de mauvaise humeur ? Réveillez-vous en douceur grâce au simulateur de lever de soleil.



DISCO FUNCTION/MODE/ DISCOFUNKTION/MODUS/ FONCTION/MODE DISCO

For the perfect party mood, the disco function synchronises the light to the beat of your favourite songs.

Für die perfekte Partystimmung schaltet die Discofunktion das Licht passend zum Beat Ihres Lieblingsongs.

Pour une ambiance festive parfaite, la fonction disco enclenche le luminaire au rythme de votre chanson préférée.



PRESENCE SIMULATOR/ ANWESENHEITSSIMULATION/ SIMULATEUR DE PRESENCE

Protect your home with the convenient presence simulator. Variable time intervals allow the system to turn the lights on and off to simulate your presence at home and deter unwanted guests.

Schütze Sie Ihr Zuhause mit der komfortablen Anwesenheitssimulation. Dank variabler Zeitintervalle simuliert das System durch Ein- und Ausschalten der Beleuchtung die Anwesenheit im Haus und schreckt so ungebetene Gäste ab.

Protégez votre domicile à l'aide du très pratique simulateur de présence. Le système simule votre présence en allumant et en éteignant les lumières à intervalles variables et décourage ainsi les invités indésirables.



VOICE COMMANDS/ SPRACHSTEUERUNG/COMMANDE VOCALE

More convenient! Turn the light on whenever you want with only a voice command.

Noch komfortabler! Mit nur einem Sprachbefehl schaltet sich das Licht nach Ihren Wünschen an und aus.

C'est encore plus confortable ! Allumez votre luminaire comme vous le souhaitez d'une simple commande vocale.



SMART HOME INTEGRATION/ EINBINDUNG SAMRT HOME/ INTÉGRATION DE LA MAISON INTELLIGENTE

Our lights can be integrated into any Zigbee smart home system.

Unsere Leuchten können in jedes Zigbee Smart Home System integriert werden.

Nos luminaires peuvent être intégrés dans n'importe quel système Zigbee Smart Home.

Control options

Steuerungsmöglichkeiten
Possibilités de commande



Set your smart home as you prefer! With the app, voice commands, or remote control.

Steuern Sie Ihr Smart Home wie Sie es möchten! Via App, Sprachsteuerung oder mit der Fernbedienung.

Commandez votre Smart Home comme vous le souhaitez ! Via l'appli, la commande vocale ou la télécommande.



APP CONTROL

Use the free app for smartphone or tablet.

Nutzen Sie die kostenlose App für das Smartphone oder Tablet.

Utilisez l'application gratuite pour smartphone ou tablette.



VOICE COMMANDS

Use intelligent voice assistants such as Google Home and Amazon Alexa.

Nutzen Sie intelligente Sprachassistenten wie Google Home und Amazon Alexa.

Utilisez des assistants vocaux intelligents comme Google Home ou Amazon Alexa.



REMOTE CONTROL

Use the practical remote connect.z operation at any time.

Nutzen Sie auch jederzeit die praktische connect.z Fernbedienung.

Vous pouvez aussi utiliser à tout moment la télécommande connect.z.



CONNECT.Z ACCESSORIES

Use clever accessories such as the motion sensor.

Nutzen Sie cleveres Zubehör wie z.B. den Bewegungssensor.

Utilisez des accessoires malins tels que le capteur de mouvement et bien d'autres encore.



DIMMER FUNCTION

Use the practical dimmer function via app, speech command or remote control.

Nutzen Sie die praktische Dimmfunktion via App, Sprachbefehl oder Fernbedienung.

Utilisez la fonction de gradation via l'appli, la commande vocale ou la télécommande.



USE IT IN ANY ZIGBEE NETWORK

Our lights can be integrated into any Zigbee smart home system.

Unsere Leuchten können in jedes Zigbee Smart Home System integriert werden.

Nos luminaires peuvent être intégrés dans n'importe quel système Zigbee Smart Home.

One system, many possibilities!

Ein System – viele Möglichkeiten!

Un système, de nombreuses possibilités!



No matter how you start, you can integrate new products into your connect.z system at any time and gradually expand your smart home.
Egal wie Sie starten, Sie können jederzeit neue Produkte in Ihr connect.z System integrieren und Ihr smartes Zuhause nach und nach erweitern.
Quel que soit votre choix, vous pouvez à tout moment intégrer de nouveaux produits à votre système connect.z et améliorer progressivement votre maison intelligente.



All you need to start is a connect.z product and the remote control. No internet connection is required and you have access to:

Sie benötigen zum Start lediglich ein connect.z Produkt und die Fernbedienung. Es wird kein Internetzugang benötigt und Sie haben Zugriff auf:

Pour démarrer, il vous suffit d'un produit connect.z et de la télécommande. Aucune connexion Internet n'est nécessaire. Vous avez accès aux :

Standard functions:
Standardfunktionen:
Fonctionnalités standard :

- › Select colour/ Farbauswahl/ sélection de couleur
- › Change colour/ Farbwechsel/ changement de couleur
- › Dim/ Dimmen/ gradation
- › Favourites (2x)/ Favoriten (2x)/ favoris (2x)
- › Groups (3x)/ Gruppen (3x)/ groupes (3x)
- › Candle mode/ Kerzenmodus/ mode bougie

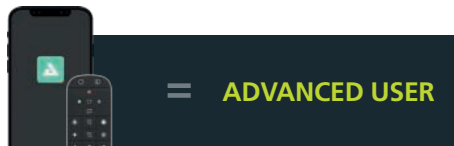

Besides the standard functions, would you also like access to the practical convenience features? Then you need only your smartphone or tablet and the Awox app. This app allows you to control your lights via Bluetooth®.

Sie möchten zu den Standardfunktionen auch noch Zugriff auf die praktischen Komfortfunktionen haben? Dann benötigen Sie nur Ihr Smartphone oder Tablet und die Awox App. Mit der App haben Sie die Möglichkeit, Ihre Leuchten über Bluetooth® zu steuern.

Outre les options standard, vous souhaitez également pouvoir utiliser les fonctionnalités de confort les plus pratiques ? Pour cela, vous avez seulement besoin de votre smartphone ou de votre tablette et de l'appli Awox. L'appli vous permet de commander vos luminaires via Bluetooth®.

Standard functions + convenience features/
Standardfunktionen + Komfortfunktionen /
Fonctionnalités standard + confort

- › Light alarm clock/ Lichtwecker/ réveil lumineux
- › Presence simulation/ Anwesenheitssimulation/ simulateur de présence
- › Disco function/ Discofunktion/ fonction disco
- › Timers & timetables /Timer & Zeitpläne/ minuteur et calendrier
- › Accessories can be incorporated/ Einbindung von Zubehör möglich/ connexion d'accessoires possible



Use the system's full potential and control your smart home through the Awox app using WIFI or Bluetooth® as well as integrating a voice assistant into the system. This gives you:

Nutzen Sie das volle Potenzial des Systems und steuern Sie Ihr Smart Home über die Awox App mithilfe von WLAN oder Bluetooth® und integrieren Sie zusätzlich noch einen Sprachassistenten in das System. So mit erhalten Sie:

Exploitez tout le potentiel du système en commandant votre Smart Home grâce à l'appli Awox via le réseau Wi-Fi ou Bluetooth®, et intégrez également un assistant vocal au système. Vous obtenez ainsi :

Standard functions + convenience features + voice commands*

Standardfunktionen + Komfortfunktionen + Sprachsteuerung*

Fonctionnalités standard + confort + commande vocale*

- › Amazon Alexa or Google Home/ Amazon Alexa oder Google Home/ Amazon Alexa ou Google Home

- * Use a voice assistant with integrated bridge.
- * Nutzen Sie einen Sprachassistenten mit integrierter Bridge.
- * Utilisez un assistant vocal avec Bridge intégré.

You already have connect-c luminaires from the previous system! What now?

Sie besitzen bereits connect-c Leuchten des Vorgängersystems! Was nun?
Vous disposez déjà de luminaires connect-c de l'ancien système! Que faire ?

No problem! The previous connect-c products are compatible with the new connect.z system.
Kein Problem! Die bisherigen connect-c Produkte sind mit dem neuen connect.z System kompatibel.
Aucun problème! Les anciens produits connect-c sont compatibles avec le nouveau système connect.z.

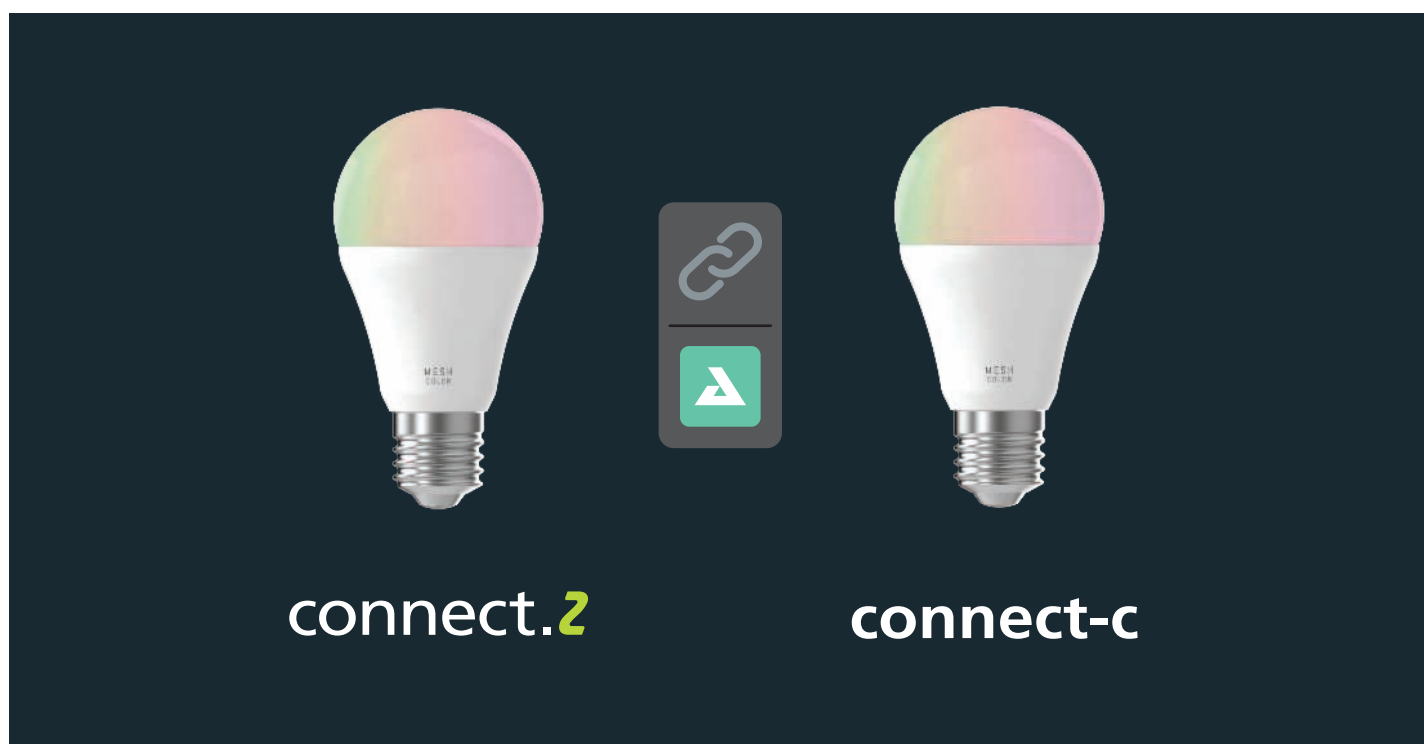

EGLO connect-c - connect.z

The existing EGLO connect-c system is compatible with the new EGLO connect.z system in the Awox Homecontrol App. You do not have to switch from the existing Bluetooth low energy system to the new open protocol ZigBee 3.0. EGLO connect-c luminaires can be integrated in the Awox app.

EGLO connect-c - connect.z

Das bestehende EGLO connect-c System ist mit dem neuen EGLO connect.z System in der Awox Homecontrol App kompatibel. Sie müssen nicht von dem bestehendem Bluetooth low energy System auf das neue offene Protokoll ZigBee 3.0 umsteigen. Leuchten von EGLO connect-c können in der Awox App eingebunden werden.

EGLO connect-c - connect.z

Le système EGLO connect-c existant est compatible avec le nouveau système EGLO connect.z dans l'application Awox Homecontrol. Vous n'avez pas besoin de passer du système Bluetooth low energy existant au nouveau protocole ouvert ZigBee 3.0. Les luminaires EGLO connect-c peuvent être intégrés dans l'application Awox.



OVERVIEW

EGLO CONNECT.Z



CONNECT Z
24



CONNECT-Z SENSOR
24



ARGOLIS-Z
26



BASALGO-Z
27



EREMITANA-Z
27



NISIA-Z
28



MONTEROLO-Z
30-31



NEON STRIPE-Z
32



E27_LED_A60
34



GU10_LED
34



This product is available in different colors and shapes. / Dieser Artikel ist in unterschiedlichen Farben und Formen verfügbar.
Cet article est disponible en différentes couleurs et formes.

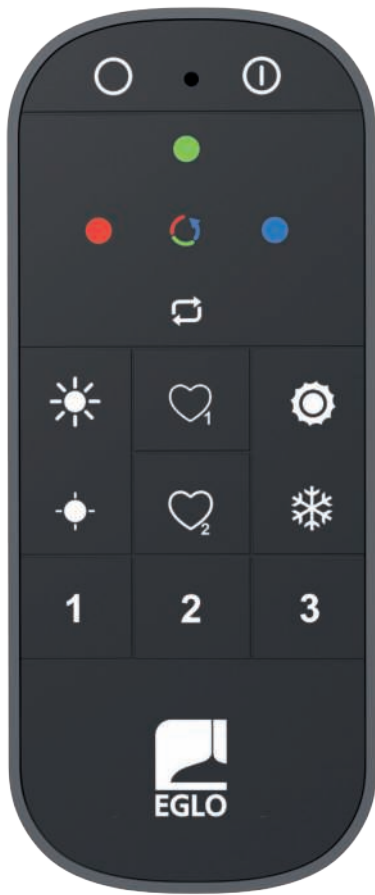

99099



99106



120°, 12 m
20 sec. - 10 min.

SAFETY & COMFORT

99099 CONNECT Z

remote control; plastic, grey
Fernbedienung; Kunststoff, grau
Télécommande; plastique, gris

L 122, B 54, H 18



AAA,
R03P



2 x 1,5V



9 002759 990992



99106 CONNECT-Z SENSOR

accessory; plastic, white
Zubehör; Kunststoff, weiss
Accessoires; plastique, blanc

L 75, H 75, A 70



AA,
LR6 HP



3 x
2900mA,



1,5V



IP44



9 002759 991067

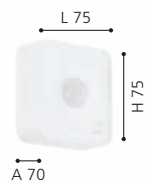



*Mounting example/
*Montage Beispiel/
*Exemple de montage

ADVANTAGES OF THE CONNECT-Z SENSOR

IP44 Safety no cabling necessary

The CONNECT-Z SENSOR is battery-operated, so that no difficult cabling is necessary. The sensor can be mounted directly on the wall. With the mounting* bracket (included in the delivery), you can easily adjust the detection range to your needs. This permits fine adjustment by 30 degrees to the left and right.

Night mode

Night mode When Night mode is enabled the luminaires receive the indication night or day from the CONNECT-Z SENSOR. Choose from 3 sensitivity settings (25 to 75%).

Night movement detection

When Night movement detection is enabled the CONNECT-Z SENSOR turns on the luminaires with the chosen light intensity when movement is detected. You can choose from 3 movement detection sensitivity settings. The light will turn off after the selected time when no movement is detected.

Combination of Night mode and Night movement detection

VORTEILE DES CONNECT-Z SENSOR

IP44 Schutz Keine Verkabelung notwendig

Der CONNECT-Z SENSOR ist batteriebetrieben, so dass keine schwierige Verkabelung erforderlich ist. Der Sensor kann direkt an die Wand montiert werden. Mit der Montagehalterung* (im Lieferumfang enthalten) können Sie den Erfassungsbereich ganz einfach an Ihre Bedürfnisse anpassen. Dadurch ist eine Feinjustierung von 30 Grad nach links und rechts möglich.

Nachtmodus

Wenn der Nachtmodus aktiviert ist, erhalten die Leuchten die Anzeige Nacht oder Tag vom CONNECT-Z SENSOR. Wählen Sie aus 3 Empfindlichkeitseinstellungen (25 bis 75%).

Nachtbewegungserkennung

Wenn die Nachtbewegungserkennung aktiviert ist, schaltet der CONNECT-Z SENSOR die Leuchten mit der gewählten Lichtintensität ein, wenn die Bewegung erkannt wird. Sie können aus 3 Bewegungserkennungseinstellungen wählen. Das Licht schaltet sich nach der gewählten Zeit aus, wenn keine Bewegung erkannt wird.

Kombination von Night mode und Night movement detection

ADVANTAGES OF THE CAPTEUR CONNECT-Z SENSOR

Protection IP44 Aucun câble nécessaire

Le CONNECT-Z SENSOR est alimenté par batterie, donc aucun câblage difficile n'est nécessaire. Avec le support de montage* (inclus dans la livraison), vous pouvez facilement ajuster l'étendue de la détection à vos besoins. Ce réglage fin de 30 degrés à gauche et à droite est possible.

Mode de nuit (Night mode)

Lorsque le mode de nuit est activé, les luminaires reçoivent l'indication du jour ou de la nuit du capteur CONNECT-Z SENSOR. Choisissez parmi 3 réglages de sensibilité (de 25 à 75%).

Détection de mouvement nocturne

Lorsque la détection de mouvement nocturne est activée, le CONNECT-Z SENSOR allume les luminaires avec l'intensité lumineuse choisie lorsqu'un mouvement est détecté. Vous pouvez choisir parmi 3 réglages de sensibilité de détection de mouvement. Si aucun mouvement n'est détecté, la lumière s'éteindra après la période sélectionnée.

Combinaison du mode de nuit et de la détection de mouvement nocturne



900124



900125



900126



900124 ARGOLIS-Z

surface-mounted light; aluminium, black / plastic, white
 Aufbauleuchte; Alu, schwarz / Kunststoff, weiss
 luminaire en saillie; aluminium, noir / plastique, blanc

L 285, B 285, H 30



900125 ARGOLIS-Z

surface-mounted light; aluminium, white / plastic, white
 Aufbauleuchte; Alu, weiss / Kunststoff, weiss
 luminaire en saillie; aluminium, blanc / plastique, blanc

L 285, B 285, H 30

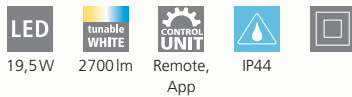

900126 ARGOLIS-Z

surface-mounted light; aluminium, black / plastic, white
 Aufbauleuchte; Alu, schwarz / Kunststoff, weiss
 luminaire en saillie; aluminium, noir / plastique, blanc

H 30, Ø 285

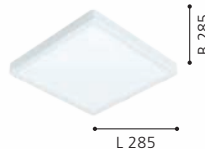



900258

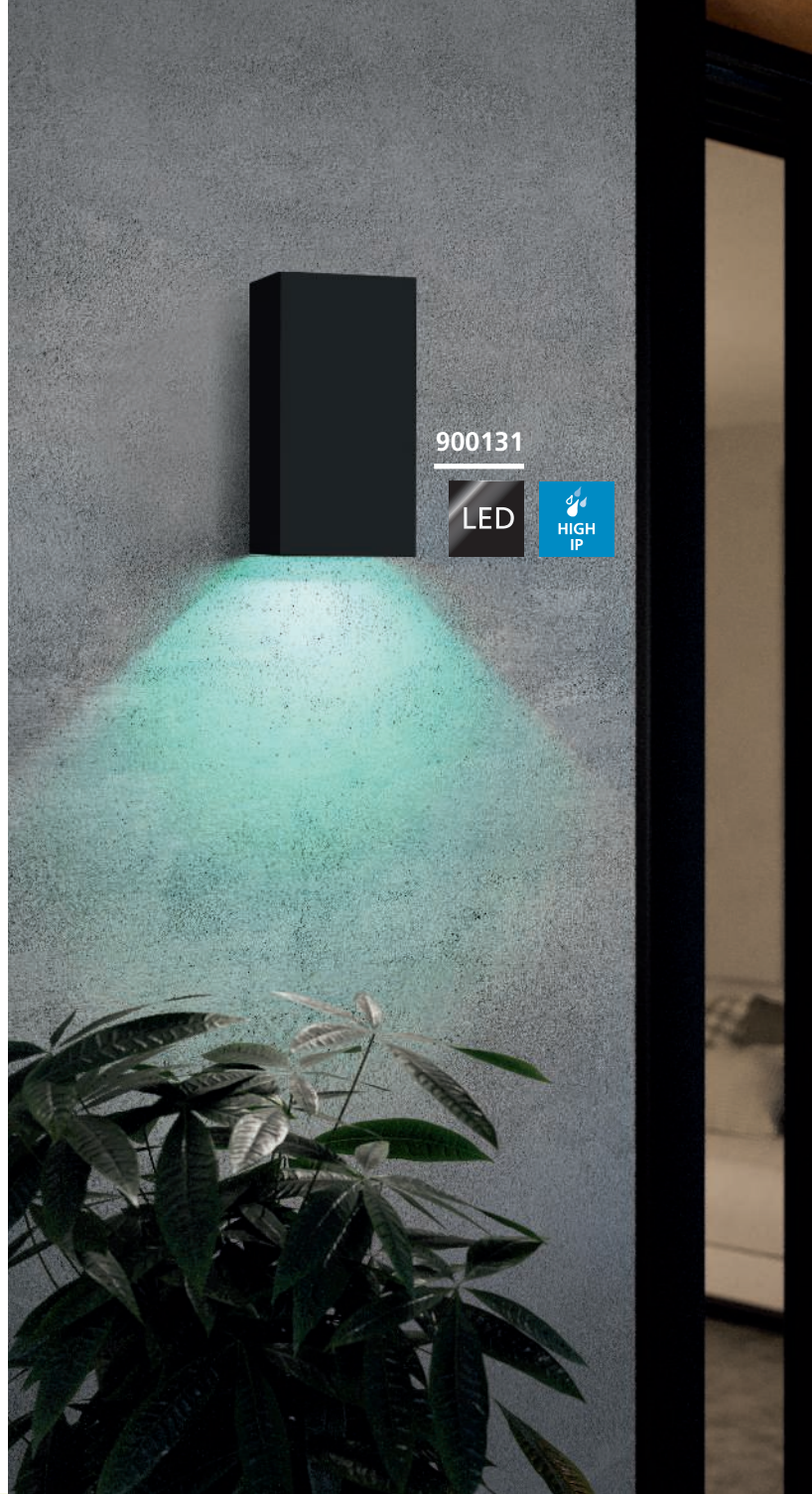

900131



900258 BASALGO-Z

pedestal light; stainless steel, black / plastic, white
 Sockelleuchte; Edelstahl, schwarz / Kunststoff, weiss
 luminaire pour socle; acier inoxydable, noir / plastique, blanc

H 450, Ø 105



E27



1x 9W



1x 806lm



Remote, App



IP44



9 008606 231515



900131 EREMITANA-Z

wall light; zinc-plated steel, black
 Wandleuchte; Stahl verzinkt, schwarz
 Applique; acier galvanisé, noir

L 110, H 240, A 110



GU10



2x 4,9W



2x 345lm



Remote, App



IP55



9 008606 230204



DIMMABLE
VIA REMOTE
AND APP



NISIA-Z

The EGLO bulb 12253 is included in the delivery.

Das EGLO Leuchtmittel 12253 ist im Lieferumfang enthalten.

L'ampoule EGLO 12253 est incluse dans la livraison.



900266

LED



900267

LED

DESIGN
HIGHLIGHT
DETAIL

900266 NISIA-Z

pedestal light; stainless steel, stainless steel / plastic, white
Sockelleuchte; Edelstahl, edelstahl / Kunststoff, weiss
luminaire pour socle; acier inoxydable, acier inoxydable /
plastique, blanc

H 525, Ø 200, Base: Ø 140

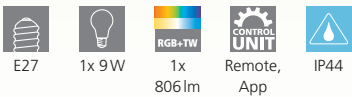

900267 NISIA-Z

floor light; stainless steel, stainless steel / plastic, white
Stehleuchte; Edelstahl, edelstahl / Kunststoff, weiss
lampadaire; acier inoxydable, acier inoxydable / plastique, blanc

H 980, Ø 200, Base: Ø 140

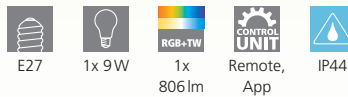

900265 NISIA-Z

wall light; stainless steel, stainless steel / plastic, white
Wandleuchte; Edelstahl, edelstahl / Kunststoff, weiss
Applique; acier inoxydable, acier inoxydable / plastique, blanc

L 200, H 315, A 220

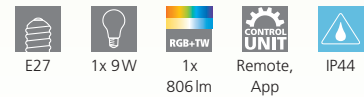



900265

LED



900268



900271



900272



900268 MONTEROLO-Z

floor light; plastic, white / plastic, white
Stehleuchte; Kunststoff, weiss / Kunststoff, weiss
lampadaire; plastique, blanc / plastique, blanc

H 300, Ø 300

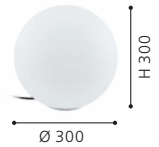
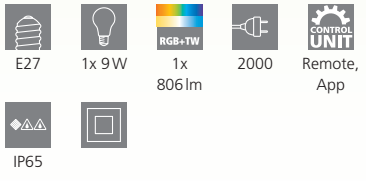

900271 MONTEROLO-Z

floor light; plastic, white / plastic, white
Stehleuchte; Kunststoff, weiss / Kunststoff, weiss
lampadaire; plastique, blanc / plastique, blanc

H 500, Ø 500

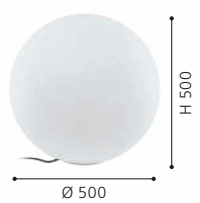
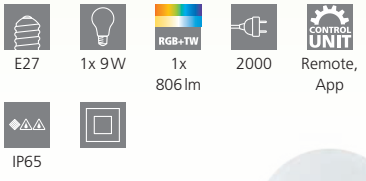

900272 MONTEROLO-Z

floor light; plastic, white / plastic, white
Stehleuchte; Kunststoff, weiss / Kunststoff, weiss
lampadaire; plastique, blanc / plastique, blanc

H 600, Ø 600

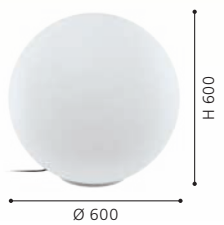
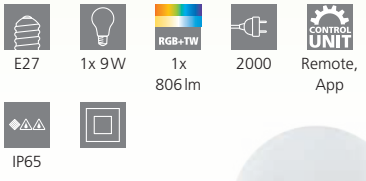



900269



900269 MONTEROLO-Z

floor light; plastic, white / plastic, white
 Stehleuchte; Kunststoff, weiss / Kunststoff, weiss
 lampadaire; plastique, blanc / plastique, blanc

H 390, Ø 390



E27



1x 9W



1x
806lm



2000



Remote,
App



IP65

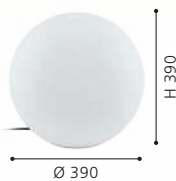

MONTEROLO-Z

The EGLO bulb 12253 is included in the delivery.

Das EGLO Leuchtmittel 12253 ist im Lieferumfang enthalten.

L'ampoule EGLO 12253 est incluse dans la livraison.



901092

LED

DIMMABLE
VIA REMOTE
AND APP



DESIGN
HIGHLIGHT
DETAIL

901092 NEON STRIPE-Z

bar/strip light; plastic, white
Leuchtband/-stab; Kunststoff, weiss
bande lumineuse / bâton l; plastique, blanc

L 5000, B 18, H 8



24 W



3200 lm



Remote,
App



IP44



9 008606 297801



901095 NEON STRIPE-Z

bar/strip light; plastic, white
Leuchtband/-stab; Kunststoff, weiss
bande lumineuse / bâton l; plastique, blanc

L 3000, B 18, H 8



21 W



2000 lm



Remote,
App



IP44



9 008606 297795















901095

LED















12253 E27-LED-A60

 806 lm	 2700-6500 K	
 L 118, Ø 60	 dimmable via remote & app	
 9 W	 15000 h	
 220-240V, 50/60Hz	 9 W ~ 60 W	
 E27	 80 CRI	



12251 GU10-LED

 345 lm	 2700-6500 K	
 L 59, Ø 50	 dimmable via remote & app	 45°
 4.9 W	 15000 h	
 220-240V, 50/60Hz	 4.9 W ~ 50 W	
 GU10	 83 CRI	





EGLO CONNECT.Z ILLUMINANT

One illuminant – numerous possibilities: 16.7 million colours and over 50,000 white tones ensure the right atmosphere in your home at all times. The illuminant can be controlled via remote control or app using Bluetooth technology: You can control the brightness or adjust colour tones – and all this without complicated installation and comfortably from the sofa.

But the illuminant can do much more: it can be expanded at will using intelligent mesh technology, and up to 50 illuminants can be grouped together. This makes it easy to create and program a wide variety of lighting scenarios. You can also use the app to select from a large number of pre-set lighting scenes.

Security is not neglected either, as the illuminants form a self-contained network and are therefore protected from external access.

EGLO CONNECT.Z LEUCHTMITTEL

Ein Leuchtmittel – zahlreiche Möglichkeiten: 16,7 Millionen Farben und über 50.000 Weißtöne sorgen jederzeit für die richtige Stimmung in Ihrem Heim. Über die Bluetooth-Technologie kann das Leuchtmittel per Fernbedienung oder App gesteuert werden: Sie können die Helligkeit kontrollieren oder Farbtöne einstellen – und das alles ohne aufwändige Installation und bequem vom Sofa aus.

Aber das Leuchtmittel kann noch viel mehr: es lässt sich per intelligenter Mesh-Technologie beliebig erweitern, bis zu 50 Leuchtmittel sind hierbei gruppierbar. So lassen sich problemlos und einfach unterschiedlichste Lichtszenarien erstellen und programmieren. Mit der App können Sie aber auch aus einer Vielzahl vorgegebener Lichtstimmungen auswählen.

Auch die Sicherheit kommt nicht zu kurz, denn die Leuchtmittel bilden ein in sich geschlossenes Netzwerk und sind somit vor Zugriffen von Außen geschützt.

AMPOULE EGLO CONNECT.Z

Une seule ampoule – de nombreuses possibilités : 16,7 millions de couleurs et plus de 50 000 tons de blanc assurent à tout moment la bonne ambiance dans votre maison. L'ampoule peut être commandée via une télécommande ou une appli, utilisant la technologie Bluetooth : Vous pouvez contrôler la luminosité ou régler les tons de couleurs – et tout cela sans installation compliquée et de manière confortablement depuis votre canapé.

Mais l'ampoule peut faire beaucoup plus : elle peut être étendue à volonté grâce à la technologie Mesh intelligentes, et jusqu'à 50 ampoules peuvent être regroupées. Il est ainsi facile de créer et de programmer une grande variété de scène lumineuse. Vous pouvez également utiliser l'appli pour sélectionner un grand nombre d'ambiance lumineuse prédéfinies.

La sécurité n'est pas négligée non plus, car les ampoules forment un réseau fermé et sont donc protégées des accès externes.



MODERN

MODERN
MODERNE

EN **CLEAR LINES**

A straight-lined and minimalist design ensures a modern touch. The luminaires made of stainless steel, aluminium or steel, combined with refined glass elements, will make your outdoor area shine in a modern light.

DE **KLARE LINIEN**

Geradliniges und minimalistisches Design sorgt für einen modernen Touch. Die Leuchten aus Edelstahl, Aluminium oder Stahl, kombiniert mit edlen Glaselementen, lassen Ihren Außenbereich modern erstrahlen.

FR **LIGNES DISTINCTIVES**











































Un design rectiligne et minimaliste apporte une touche de modernité. Les luminaires en acier inoxydable, en aluminium ou en acier, combinés à de nobles éléments en verre, font briller votre espace extérieur de modernité.





OVERVIEW

MODERN
MODERN
MODERNE

 RIFORANO 40-41	 NEMBRO 42	 MANFRIA 42	 DONINNI 1 44-45	 MELZO 46	 FIUMICINO 48-49	 PALOSCO 50	 CALDIERO 50
 STAGNONE 51	 ENTRIMO 52	 NINNARELLA 53	 FORNACI 54	 NIVAROLO 54	 PERNATE 55	 CHIAPPERA 56	 RAVELLO 58-59
 SELINUS 59	 FANDINA 60	 SERRICELLA 60	 UGENTO 62-63	 TAPARITA 63	 SALITTA 64-65	 NEVIANO 67	 MORINO 68
 REDONDO 68	 VILLAGRAZIA 70	 BELCREDA 71	 CHINOA 71	 SESIMBA 1 72	 TREVILO 72	 FARINDOLA 74	 GORZANO 75
 SPIAZZINA 75	 PREDAZZO 75	 SORRONARO 76	 BRIANZA 76	 SITIA 77	 KIBEA 77	 COSTORIO 78	 BITETTO 78
 BUFALATA 78-79	 BUDRONE 81						

 This product is available in different colors and shapes. /
Dieser Artikel ist in unterschiedlichen Farben und Formen verfügbar.
Cet article est disponible en différentes couleurs et formes.





98725



98727



98728



98725 RIFORANO

wall light; cast aluminium, black / plastic, white
Wandleuchte; Aluguss, schwarz / Kunststoff, weiss
Applique; fonte d'aluminium, noir / plastique, blanc

L 110, H 290, A 85



98727 RIFORANO

pedestal light; cast aluminium, black / plastic, white
Sockelleuchte; Aluguss, schwarz / Kunststoff, weiss
luminaire pour socle; fonte d'aluminium, noir / plastique, blanc

L 110, B 60, H 340



98728 RIFORANO

floor light; cast aluminium, black / plastic, white
Stehleuchte; Aluguss, schwarz / Kunststoff, weiss
lampadaire; fonte d'aluminium, noir / plastique, blanc

L 110, B 60, H 770





98726



120°, 6 m
10 sec. - 8 min.

**SAFETY &
COMFORT**

98726 RIFORANO

wall light; cast aluminium, black / plastic, white
Wandleuchte; Aluguss, schwarz / Kunststoff, weiss
Applique; fonte d'aluminium, noir / plastique, blanc

L 110, H 290, A 95



2x 5W



1100lm



IP44



9 002759 987268





98751



98096



98751 NEMBRO

floor light; cast aluminium, black / plastic, white
 Stehleuchte; Aluguss, schwarz / Kunststoff, weiss
 lampadaire; fonte d'aluminium, noir / plastique, blanc

L 200, B 110, H 800



9 002759 987510



98096 MANFRIA

pedestal light; aluminium, anthracite, white
 Sockelleuchte; Alu, anthrazit, weiss
 luminaire pour socle; aluminium, gris anthracite, blanc

L 135, B 75, H 380



9 002759 980962



98097 MANFRIA

floor light; aluminium, anthracite, white
 Stehleuchte; Alu, anthrazit, weiss
 lampadaire; aluminium, gris anthracite, blanc

L 135, B 75, H 870



9 002759 980979

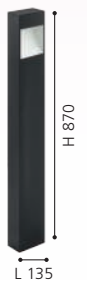



98097

LED



98266



98271



98269



98266 DONINNI 1

wall light; aluminium, white / plastic, white
Wandleuchte; Alu, weiss / Kunststoff, weiss
Applique; aluminium, blanc / plastique, blanc

98269 DONINNI 1

wall light; aluminium, anthracite / plastic, white
Wandleuchte; Alu, anthrazit / Kunststoff, weiss
Applique; aluminium, gris anthracite / plastique, blanc

98271 DONINNI 1

pedestal light; aluminium, anthracite / plastic, white
Sockelleuchte; Alu, anthrazit / Kunststoff, weiss
luminaire pour socle; aluminium, gris anthracite / plastique, blanc

L 135, B 120, H 75



L 135, B 120, H 75



L 135, B 75, H 400



9 002759 982669

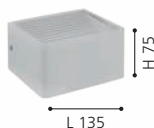

9 002759 982690



9 002759 982713





98272

LED

HIGH
IP

98272 DONINNI 1

floor light; aluminium, anthracite / plastic, white
 Stehleuchte; Alu, anthrazit / Kunststoff, weiss
 lampadaire; aluminium, gris anthracite / plastique, blanc

L 135, B 75, H 800

LED

6,2W

warm
WHITE

550lm



IP65

IP65



9 002759 982720



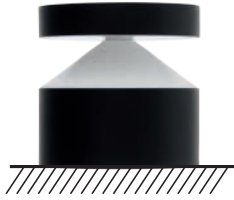
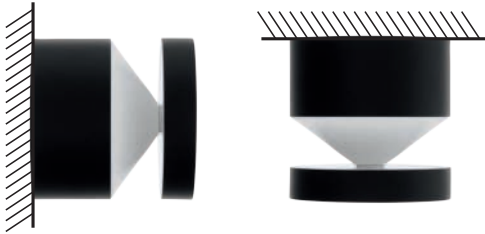

97303

These luminaires are versatile: they can be mounted both on the wall and on the ceiling. Floor placement is also possible thanks to the variable design of the lights.

Diese Leuchten sind vielseitig einsetzbar: sie können sowohl an der Wand, als auch an der Decke montiert werden. Ebenfalls ist durch das variable Design der Leuchten eine Bodenplatzierung möglich.

Ces luminaires sont polyvalents : ils peuvent être montés aussi bien au mur qu'au plafond. De même, le design variable des luminaires permet de les placer au sol.



97632



97632 MELZO

pedestal light; cast aluminium, black / plastic, transparent
Sockelleuchte; Aluguss, schwarz / Kunststoff, transparent
luminaire pour socle; fonte d'aluminium, noir / plastique, transparent

H 450, Ø 135



1x 11 W 1300lm



9 002759 976323



97303 MELZO

wall light; cast aluminium, black / plastic, transparent
Wandleuchte; Aluguss, schwarz / Kunststoff, transparent
Applique; fonte d'aluminium, noir / plastique, transparent

H 130, Ø 135



1x 11 W 1300lm



9 002759 973032



97304 MELZO

floor light; cast aluminium, black / plastic, transparent
Stehleuchte; Aluguss, schwarz / Kunststoff, transparent
lampadaire; fonte d'aluminium, noir / plastique, transparent

H 990, Ø 135



1x 11 W 1300lm



9 002759 973049





97303

LED



97304

LED





98148



98149



100°, 5 m
5 sec. - 5 min.

**SAFETY &
COMFORT**



98151



98148 FIUMICINO

wall light; aluminium, black / plastic, white
Wandleuchte; Alu, schwarz / Kunststoff, weiss
Applique; aluminium, noir / plastique, blanc

L 70, H 180, A 190



11,5W 1200lm



9 002759 981488



98149 FIUMICINO

wall light; aluminium, black / plastic, white
Wandleuchte; Alu, schwarz / Kunststoff, weiss
Applique; aluminium, noir / plastique, blanc

L 70, H 180, A 190



11,5W 1200lm



9 002759 981495



98151 FIUMICINO

pedestal light; aluminium, black / plastic, white
Sockelleuchte; Alu, schwarz / Kunststoff, weiss
luminaire pour socle; aluminium, noir / plastique, blanc

H 450, Base: B 110, T 80



11,5W 1200lm



9 002759 981518





98152 FIUMICINO

floor light; aluminium, black / plastic, white
Stehleuchte; Alu, schwarz / Kunststoff, weiss
lampadaire; aluminium, noir / plastique, blanc

H 900, Base: B 110, T 80



11,5W



1200lm



IP44



9 002759 981525



98152

LED



97451



90°, 6 m
10 sec. - 10 min.

**SAFETY &
COMFORT**



98738



90°, 6 m
10 sec. - 12 min.

**SAFETY &
COMFORT**



97146

98738 PALOSCO

wall light; zinc-plated steel, black / plastic, transparent
Wandleuchte; Stahl verzinkt, schwarz / Kunststoff, transparent
Applique; acier galvanisé, noir / plastique, transparent

L 115, H 170, A 155



4,9W



360lm



IP44



9 002759 987381



97451 CALDIERO

wall light; zinc-plated steel, anthracite / plastic, white
Wandleuchte; Stahl verzinkt, anthrazit / Kunststoff, weiss
Applique; acier galvanisé, gris anthracite / plastique, blanc

L 140, H 240, A 185



E27



1x 10W



IP44



9 002759 974510



97146 CALDIERO

wall light; zinc-plated steel, anthracite / plastic, white
Wandleuchte; Stahl verzinkt, anthrazit / Kunststoff, weiss
Applique; acier galvanisé, gris anthracite / plastique, blanc

L 140, H 240, A 185



E27



1x 10W



IP44



9 002759 971465





900691



900692



900691 STAGNONE

wall light; aluminium, steel, black / glass, clear
Wandleuchte; Alu, Stahl, schwarz / Glas, klar
Applique; aluminium, acier, noir / verre, transparent

L 100, H 205, A 125



GU10



1x 4,6W



1x

400lm



IP54



9 008606 261857



900692 STAGNONE

pedestal light; aluminium, steel, black / glass, clear
Sockelleuchte; Alu, Stahl, schwarz / Glas, klar
luminaire pour socle; aluminium, acier, noir / verre, transparent

L 100, B 125, H 1000



GU10



1x 4,6W



1x

400lm



IP54



9 008606 261864





96207



96207 ENTRIMO

wall light; zinc-plated steel, black / plastic, white
Wandleuchte; Stahl verzinkt, schwarz / Kunststoff, weiss
Applique; acier galvanisé, noir / plastique, blanc

L 200, H 185, A 235



E27



1x 40W



IP44





900688

LED



900689

LED



900688 NINNARELLA

wall light; steel, black / plastic, white
Wandleuchte; Stahl, schwarz / Kunststoff, weiss
Applique; acier, noir / plastique, blanc

L 205, H 110, A 240



GU10



1x 4,6W



1x
warm
WHITE

400lm



IP44



9 008606 261833



900689 NINNARELLA

pedestal light; steel, black / plastic, white
Sockelleuchte; Stahl, schwarz / Kunststoff, weiss
luminaire pour socle; acier, noir / plastique, blanc

L 250, B 205, H 745



GU10



1x 4,6W



1x
warm
WHITE

400lm



IP44



9 008606 261840





900673



900675



900674



90°, 8 m
10 sec. - 8 min.

**SAFETY &
COMFORT**

900673 FORNACI

wall light; steel, black / plastic, white
Wandleuchte; Stahl, schwarz / Kunststoff, weiss
Applique; acier, noir / plastique, blanc

900674 FORNACI

wall light; steel, black / plastic, white
Wandleuchte; Stahl, schwarz / Kunststoff, weiss
Applique; acier, noir / plastique, blanc

900675 NIVAROLO

wall light; steel, black / plastic, white
Wandleuchte; Stahl, schwarz / Kunststoff, weiss
Applique; acier, noir / plastique, blanc

L 160, H 135, A 190



L 160, H 135, A 190



L 145, H 135, A 185

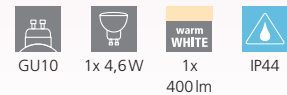



97308



120°, 6 m
10 sec. - 8 min.

**SAFETY &
COMFORT**

97308 PERNATE

wall light; cast aluminium, anthracite / plastic, white
Wandleuchte; Aluguss, anthrazit / Kunststoff, weiss
Applique; fonte d'aluminium, gris anthracite / plastique, blanc

L 250, H 235, A 170



11 W



1250lm



IP44



9 002759 973087





900287



900802



900287 CHIAPPERA

wall light; steel, black, white / glass, clear
Wandleuchte; Stahl, schwarz, weiss / Glas, klar
Applique; acier, noir, blanc / verre, transparent

L 220, H 225, A 245



900802 CHIAPPERA

pedestal light; steel, black, white / glass, clear
Sockelleuchte; Stahl, schwarz, weiss / Glas, klar
luminaire pour socle; acier, noir, blanc / verre, transparent

H 330, Ø 220

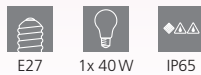

900803 CHIAPPERA

path light; steel, black, white / glass, clear
Wegeleuchte; Stahl, schwarz, weiss / Glas, klar
Éclairage du chemin; acier, noir, blanc / verre, transparent

H 800, Ø 220





900803





98721



98723



98721 RAVELLO

wall light; zinc-plated steel, black / plastic, white
Wandleuchte; Stahl verzinkt, schwarz / Kunststoff, weiss
Applique; acier galvanisé, noir / plastique, blanc

L 165, H 275, A 225



E27



1x 28W



IP44

98723 RAVELLO

pedestal light; zinc-plated steel, black / plastic, white
Sockelleuchte; Stahl verzinkt, schwarz / Kunststoff, weiss
luminaire pour socle; acier galvanisé, noir / plastique, blanc

H 450, Ø 165, Base: Ø 115



E27



1x 28W



IP54





98724



900672



900684



98724 RAVELLO

floor light; zinc-plated steel, black / plastic, white
 Stehleuchte; Stahl verzinkt, schwarz / Kunststoff, weiss
 lampadaire; acier galvanisé, noir / plastique, blanc

H 1100, Ø 165, Base: Ø 115



900672 SELINUS

wall light; steel, black / glass, clear
 Wandleuchte; Stahl, schwarz / Glas, klar
 Applique; acier, noir / verre, transparent

L 190, H 220, A 220



900684 SELINUS

floor light; steel, black / glass, clear
 Stehleuchte; Stahl, schwarz / Glas, klar
 lampadaire; acier, noir / verre, transparent

L 290, B 190, H 845, Base: Ø 140

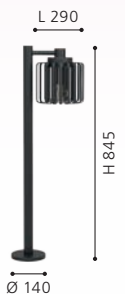

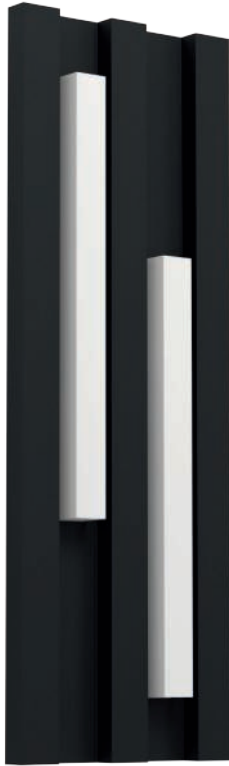

900118



900119



900118 FANDINA

wall light; zinc-plated steel, black / plastic, white
 Wandleuchte; Stahl verzinkt, schwarz / Kunststoff, weiss
 Applique; acier galvanisé, noir / plastique, blanc

L 145, H 415, A 55



2x 4,2W 1000lm



9 008606 230150



900119 FANDINA

wall light; zinc-plated steel, white / plastic, white
 Wandleuchte; Stahl verzinkt, weiss / Kunststoff, weiss
 Applique; acier galvanisé, blanc / plastique, blanc

L 145, H 415, A 55



2x 4,2W 1000lm



9 008606 230167



900133 SERRICELLA

wall light; zinc-plated steel, black / plastic, white
 Wandleuchte; Stahl verzinkt, schwarz / Kunststoff, weiss
 Applique; acier galvanisé, noir / plastique, blanc

L 100, H 495, A 60



2x 4,5W 1100lm



9 008606 230174



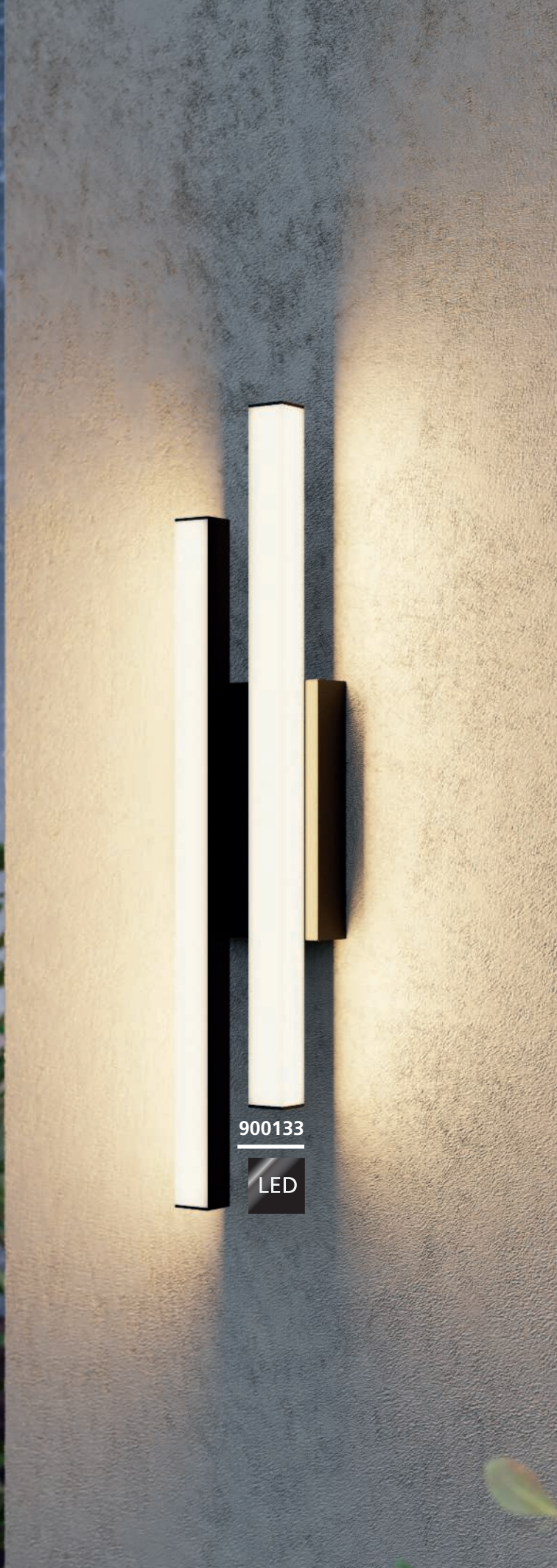

900133

LED



900709

LED



900709

Regarding to its flexible head, these luminaires can be radiate forward or backward.

Diese Leuchten können durch ihren flexiblen Kopf nach vorne oder hinten strahlen.

Grâce à sa tête flexible, cette luminaires peut être rayonner vers l'avant ou vers l'arrière.



900709 UGENTO

wall light; steel, black / plastic, white
Wandleuchte; Stahl, schwarz / Kunststoff, weiss
Applique; acier, noir / plastique, blanc

L 60, H 315, A 95



2x 4,5W



920lm



IP44



9 008606 261789



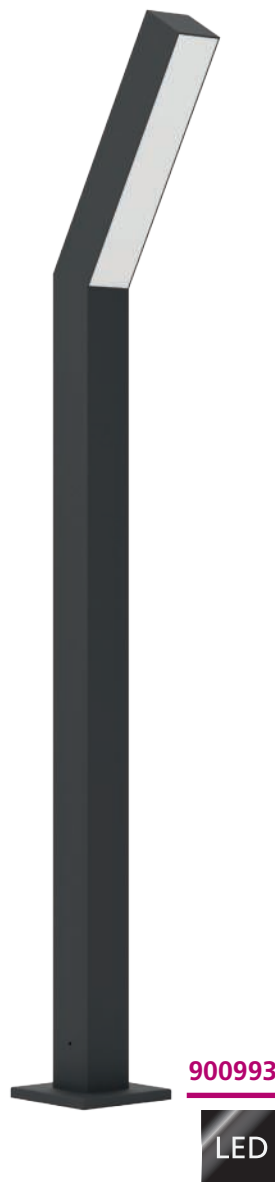

900992 UGENTO

pedestal light; aluminium, steel, black / plastic, white
Sockelleuchte; Alu, Stahl, schwarz / Kunststoff, weiss
luminaire pour socle; aluminium, acier, noir / plastique, blanc

L 145, B 40, H 360, Base: B 85, T 85



900993 UGENTO

floor light; aluminium, steel, black / plastic, white
Stehleuchte; Alu, Stahl, schwarz / Kunststoff, weiss
lampadaire; aluminium, acier, noir / plastique, blanc

L 165, B 40, H 790, Base: B 85, T 85



900681 TAPARITA

wall light; steel, black / plastic, white
Wandleuchte; Stahl, schwarz / Kunststoff, weiss
Applique; acier, noir / plastique, blanc

L 90, H 440, A 110





900261



900263



900264



900261 SALITTA

surface-mounted light; aluminium, steel, black / plastic, white
Aufbauleuchte; Alu, Stahl, schwarz / Kunststoff, weiss
luminaire en saillie; aluminium, acier, noir / plastique, blanc

900263 SALITTA

recessed light; aluminium, steel, black / plastic, white
Einbauleuchte; Alu, Stahl, schwarz / Kunststoff, weiss
luminaire encastrable; aluminium, acier, noir / plastique, blanc

900264 SALITTA

recessed light; aluminium, steel, black / plastic, white
Einbauleuchte; Alu, Stahl, schwarz / Kunststoff, weiss
luminaire encastrable; aluminium, acier, noir / plastique, blanc

L 380, B 55, H 55



L 400, B 75, H 55, ET 52



L 600, B 75, H 55, ET 52

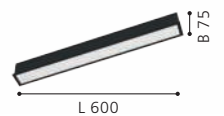



900262

LED

HIGH
IP

900262 SALITTA

surface-mounted light; aluminium, steel, black / plastic, white
Aufbauleuchte; Alu, Stahl, schwarz / Kunststoff, weiss
luminaire en saillie; aluminium, acier, noir / plastique, blanc

L 580, B 55, H 55

LED

14W

warm
WHITE

1680lm



IP65



L 580





900676





900677



900678



900676 NEVIANO

wall light; steel, plastic, black / plastic, white
Wandleuchte; Stahl, Kunststoff, schwarz / Kunststoff, weiss
Applique; acier, plastique, noir / plastique, blanc

L 380, H 65, A 50



2x 3,7W 1200lm



9 008606 261932

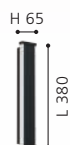

900677 NEVIANO

wall light; steel, plastic, black / plastic, white
Wandleuchte; Stahl, Kunststoff, schwarz / Kunststoff, weiss
Applique; acier, plastique, noir / plastique, blanc

L 580, H 65, A 50



2x 7W 2100lm



9 008606 261949



900678 NEVIANO

wall light; steel, plastic, black / plastic, white
Wandleuchte; Stahl, Kunststoff, schwarz / Kunststoff, weiss
Applique; acier, plastique, noir / plastique, blanc

L 970, H 65, A 50



2x 11W 4200lm



9 008606 261956





93319

LED



93318

LED

93319 MORINO

wall light; cast aluminium, anthracite
Wandleuchte; Aluguss, anthrazit
Applique; fonte d'aluminium, gris anthracite

L 140, H 180, A 105



2x 2,5W 460lm



9 002759 933197

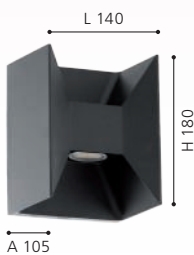

93318 MORINO

wall light; cast aluminium, white
Wandleuchte; Aluguss, weiss
Applique; fonte d'aluminium, blanc

L 140, H 180, A 105



2x 2,5W 460lm



9 002759 933180

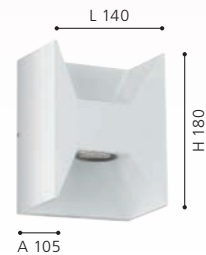

93368 REDONDO

wall light; cast aluminium, anthracite
Wandleuchte; Aluguss, anthrazit
Applique; fonte d'aluminium, gris anthracite

L 160, H 175, A 125



2x 2,5W 460lm



9 002759 933685





93368

LED



98154

LED



98153

LED

98154 VILLAGRAZIA

wall light; aluminium, black / glass with air bubbles, clear
 Wandleuchte; Alu, schwarz / Glas mit Lufteinschlüssen, klar
 Applique; aluminium, noir / verre avec bulles d'air, transparent

L 120, H 400, A 70



2x 3,3W



680lm



IP44

L 120



H 400

A 70



9 002759 981549

98153 VILLAGRAZIA

wall light; aluminium, black / glass with air bubbles, clear
 Wandleuchte; Alu, schwarz / Glas mit Lufteinschlüssen, klar
 Applique; aluminium, noir / verre avec bulles d'air, transparent

L 120, H 300, A 70



2x 3,3W



680lm



IP44

L 120



H 300

A 70



9 002759 981532



98709

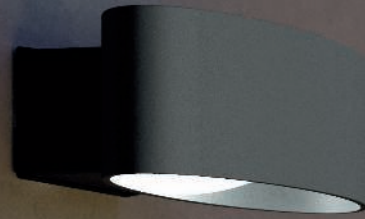

98711



97312



120°, 6 m
10 sec. - 8 min.

**SAFETY &
COMFORT**

97312 BELCREDA

wall light; cast aluminium, anthracite / plastic, white
Wandleuchte; Aluguss, anthrazit / Kunststoff, weiss
Applique; fonte d'aluminium, gris anthracite / plastique, blanc

L 330, H 125, A 165



9W 1200lm



IP44



9 002759 973124



98709 CHINOA

wall light; aluminium, steel, white / plastic, transparent
Wandleuchte; Alu, Stahl, weiss / Kunststoff, transparent
Applique; aluminium, acier, blanc / plastique, transparent

L 270, H 75, A 135



10W 1300lm



IP54



9 002759 987091

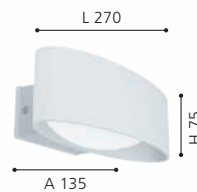

98711 CHINOA

wall light; aluminium, steel, anthracite / plastic, transparent
Wandleuchte; Alu, Stahl, anthrazit / Kunststoff, transparent
Applique; aluminium, acier, gris anthracite / plastique, transparent

L 270, H 75, A 135



10W 1300lm



IP54



9 002759 987114

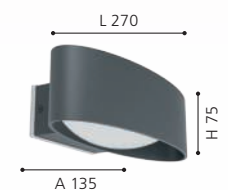



96021



90°, 6 m
10 sec. - 10 min.

**SAFETY &
COMFORT**



98747



96021 SESIMBA 1

wall light; zinc-plated steel, black / plastic, clear
Wandleuchte; Stahl verzinkt, schwarz / Kunststoff, klar
Applique; acier galvanisé, noir / plastique, transparent

L 130, H 195, A 140



2x 3,7W



660lm



IP44



9 002759 960216



98747 TREVILO

wall light; cast aluminium, white / glass, clear
Wandleuchte; Aluguss, weiss / Glas, klar
Applique; fonte d'aluminium, blanc / verre, transparent

L 90, H 85, A 120



2x 2,2W



460lm



IP44



9 002759 987473

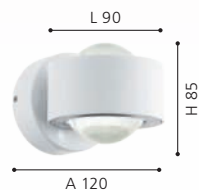

98746 TREVILO

wall light; cast aluminium, anthracite / glass, clear
Wandleuchte; Aluguss, anthrazit / Glas, klar
Applique; fonte d'aluminium, gris anthracite / verre, transparent

L 90, H 85, A 120



2x 2,2W



460lm



IP44



9 002759 987466





98746

LED



900682

900682 FARINDOLA

wall light; steel, black / plastic, white
Wandleuchte; Stahl, schwarz / Kunststoff, weiss
Applique; acier, noir / plastique, blanc

L 115, H 325, A 155



E27



1x 25W



IP44



9 008606 261703

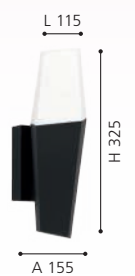



97222



900132



93994



97222 GORZANO

wall light; zinc-plated steel, anthracite / plastic, satin finish
Wandleuchte; Stahl verzinkt, anthrazit / Kunststoff, satiniert
Applique; acier galvanisé, gris anthracite / plastique, satiné

L 80, H 290, A 105



1x 4,8W



550lm



IP44



9 002759 972226

900132 SPIAZZINA

wall light; zinc-plated steel, black, white
Wandleuchte; Stahl verzinkt, schwarz, weiss
Applique; acier galvanisé, noir, blanc

L 80, H 355, A 140



2x 2,5W



360lm



IP55



9 008606 230211

93994 PREDAZZO

wall light; zinc-plated steel, anthracite, white
Wandleuchte; Stahl verzinkt, anthrazit, weiss
Applique; acier galvanisé, gris anthracite, blanc

L 140, H 210, A 75



2x 2,5W



460lm



IP44



9 002759 939946

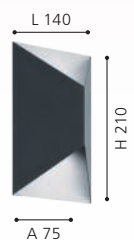



99578



98707



99578



98707



98707

The movable light head allows you to select different lighting scenes as required.

Durch den beweglichen Leuchtenkopf können Sie nach Belieben unterschiedliche Lichtszenen wählen.

La tête de luminaire mobile vous permet de sélectionner différentes scènes lumineuses en fonction de vos besoins.

99578 SORRONARO

wall light; aluminium, plastic, black / plastic, transparent
 Wandleuchte; Alu, Kunststoff, schwarz / Kunststoff, transparent
 Applique; aluminium, plastique, noir / plastique, transparent

L 170, H 50, A 150

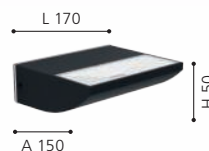

98707 BRIANZA

wall light; cast aluminium, black
 Wandleuchte; Aluguss, schwarz
 Applique; fonte d'aluminium, noir

L 200, H 50, A 140

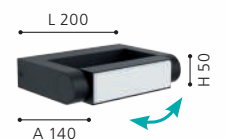



95988



93254



95988 SITIA

wall light; zinc-plated steel, anthracite / plastic, white
Wandleuchte; Stahl verzinkt, anthrazit / Kunststoff, weiss
Applique; acier galvanisé, gris anthracite / plastique, blanc

L 180, H 180, A 55



2x 4,8W



1100lm



IP44



9 002759 959883

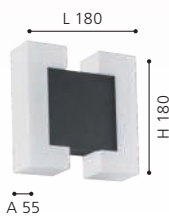

93254 KIBEA

wall light; zinc-plated steel, white, anthracite
Wandleuchte; Stahl verzinkt, weiss, anthrazit
Applique; acier galvanisé, blanc, gris anthracite

L 150, H 260, A 75



2x 2,5W



460lm



IP54



9 002759 932541





900291



900679



900669

900291 COSTORIO

wall light; aluminium, black, brown
Wandleuchte; Alu, schwarz, braun
Applique; aluminium, noir, marron

L 370, B 80, H 80



11,7W 1500lm

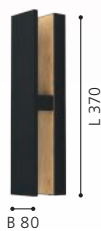

900679 BITETTO

wall light; steel, brown / plastic, white
Wandleuchte; Stahl, braun / Kunststoff, weiss
Applique; acier, marron / plastique, blanc

L 120, H 430, A 55



7W 770lm



900669 BUFALATA

wall light; steel, black / plastic, white
Wandleuchte; Stahl, schwarz / Kunststoff, weiss
Applique; acier, noir / plastique, blanc

L 200, H 290, A 275



E27 1x 40W IP44





900671

900671 BUFALATA

wall light; steel, black, brown / plastic, black-transparent
Wandleuchte; Stahl, schwarz, braun / Kunststoff, schwarz-transparent
Applique; acier, noir, marron / plastique, noir transparent

L 200, H 290, A 275



E27



1x 40W



IP44



9 008606 261765

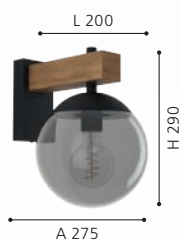



900289

900288, 900289

These luminaires can be mounted upwards or downwards.

Diese Leuchten können aufwärts oder abwärts montiert werden.

Ces luminaires peut être montée vers le haut ou vers le bas.



900288



900289 BUDRONE

wall light; steel, black, brown / glass, clear
Wandleuchte; Stahl, schwarz, braun / Glas, klar
Applique; acier, noir, marron / verre, transparent

L 120, H 270, A 165



E27



1x 40W



IP44



9 008606 231591

900288 BUDRONE

wall light; steel, black / glass, clear
Wandleuchte; Stahl, schwarz / Glas, klar
Applique; acier, noir / verre, transparent

L 120, H 270, A 165



E27



1x 40W



IP44



9 008606 231607



TIMELESS

ZEITLOS
SANS TEMPS

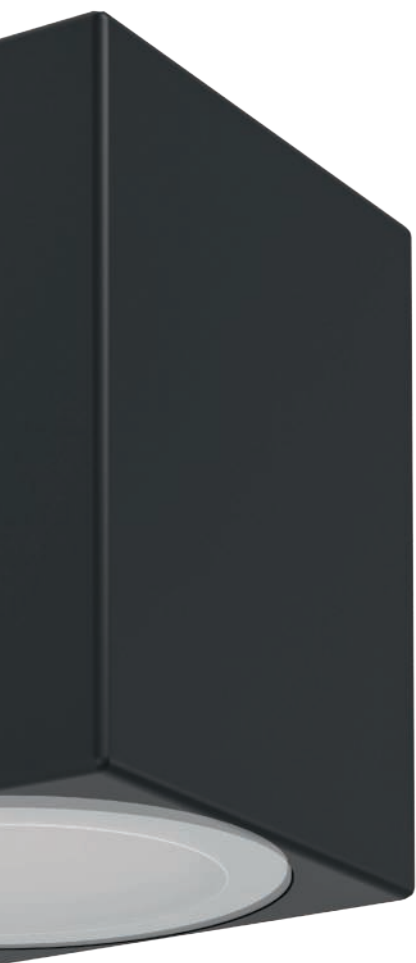

EN TIMELESS CLASSICS

Our outdoor lamps bring timeless sophistication to every corner, creating an inviting ambiance that withstands the test of time and nature.

DE ZEITLOSE KLASSIKER

Unsere Außenleuchten verleihen jeder Ecke zeitlose Raffinesse und schaffen eine einladende Atmosphäre, die den Lauf der Zeit und die Einflüsse der Natur überdauert.

FR DES CLASSIQUES INTEMPORELS

Nos luminaires d'extérieur confèrent à chaque coin un raffinement intemporel et créent une atmosphère accueillante qui résiste au passage du temps et aux influences de la nature.





OVERVIEW

TIMELESS
ZEITLOS
SANS TEMPS



ALAMONTE 3
86-87



ALAMONTE
88



ALAMONTE 1
88-90



CASCINETTA
90-91



SALLE
92



HELSINKI
95-97



NISIA
98



RUBIO
100



PRATA VECCHIA
100



TAVERNA
100-101



ARGOLIS 2
102-103



IPHIAS 2
102



RONCO
103



SONELLA
104



CORNALE
104



AZZINANO
105



MADRIZ
106



SALVANESCO
106



VENTO 2
106



VENTO 1
107



TRONO STICK
108



BEVERLY
108



STOCKHOLM 1
108



BOSARO
109



ROBLEDO
109



RIGA
110-111



AGOLADA
112



RIGA-LED
112-113



TONEGO
113



RIGA 5
114-115



ATOLLARI
116



CISTIerna 2
117



CISTIerna
117



SAKEDA
118



JORBA
118



DESELLA 1
118



GRUTTI
120



EREMITANA
121



JABAGA
121



IZZALINI
122



TORRECOLA
123

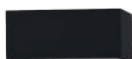

SPONGANO
124



MARUGGIO
125



CALPINO 2
126



CALPINO
126



LESMO
127



CALPINO 3
128-129



CAMARDA
130-131

 This product is available in different colors and shapes. /
Dieser Artikel ist in unterschiedlichen Farben und Formen verfügbar.
Cet article est disponible en différentes couleurs et formes.



CASAZZA
133



MUSSOTTO
133



VERRES
133



BREGANZO 1
135



BREGANZO
135



PARK
135



TRIBANO
136



CERNO
136-137



CITY
138-139





900137



90°, 6 m
10 sec. - 12 min.

**SAFETY &
COMFORT**



900138

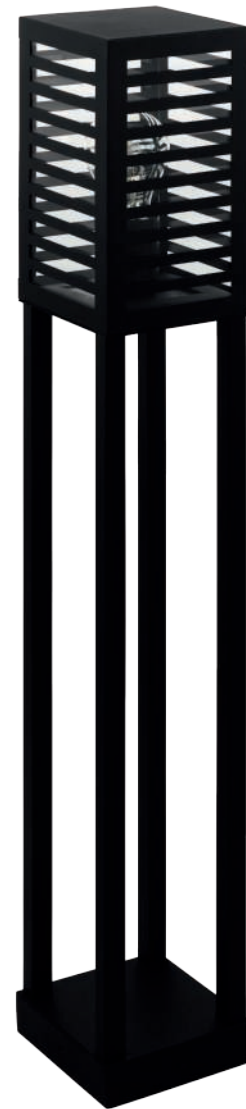

900139

900137 ALAMONTE 3

wall light; aluminium, steel, black
Wandleuchte; Alu, Stahl, schwarz
Applique; aluminium, acier, noir

L 170, H 295, A 100

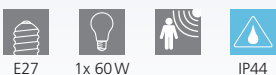

900138 ALAMONTE 3

pedestal light; aluminium, steel, black
Sockelleuchte; Alu, Stahl, schwarz
luminaire pour socle; aluminium, acier, noir

L 150, B 150, H 450

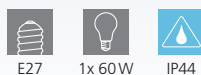

900139 ALAMONTE 3

floor light; aluminium, steel, black
Stehleuchte; Alu, Stahl, schwarz
lampadaire; aluminium, acier, noir

L 150, B 150, H 1000

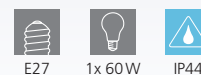





900136

900136 ALAMONTE 3

wall light; aluminium, steel, black
 Wandleuchte; Alu, Stahl, schwarz
 Applique; aluminium, acier, noir

L 170, H 260, A 100

-  E27
-  1x 60 W
-  IP44

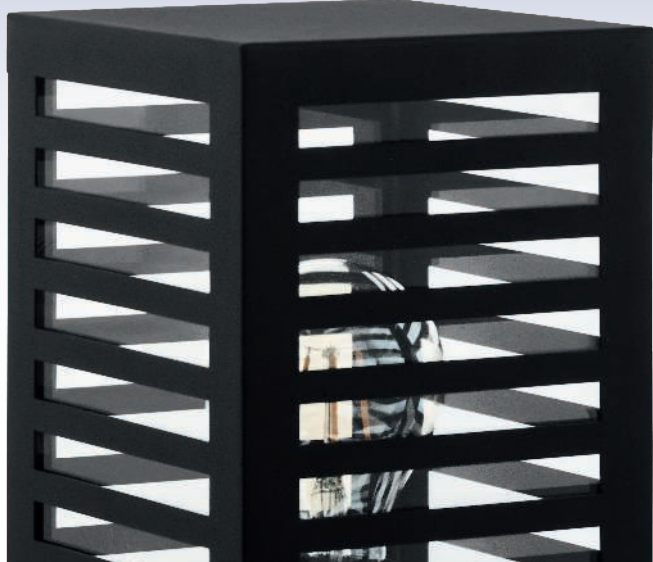



99587



105°, 9 m
8 sec. - 9 min.

**SAFETY &
COMFORT**



98273



94831

99587 ALAMONTE

wall light; steel, black / glass, clear
Wandleuchte; Stahl, schwarz / Glas, klar
Applique; acier, noir / verre, transparent

L 170, H 295, A 115

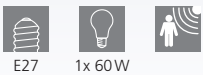

E27 1x 60W



9 002759 995874

98273 ALAMONTE 1

wall light; steel, black / glass, clear
Wandleuchte; Stahl, schwarz / Glas, klar
Applique; acier, noir / verre, transparent

L 150, H 380, A 100

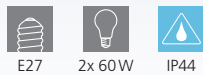

E27 2x 60W IP44



9 002759 982737

94831 ALAMONTE 1

wall light; steel, black / glass, clear
Wandleuchte; Stahl, schwarz / Glas, klar
Applique; acier, noir / verre, transparent

L 170, H 260, A 100

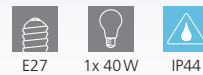

E27 1x 40W IP44



9 002759 948313



900698



94832

900698 ALAMONTE 1

wall light; steel, black / glass, clear
Wandleuchte; Stahl, schwarz / Glas, klar
Applique; acier, noir / verre, transparent

L 290, H 260, A 100



E27



2x 40W



IP44

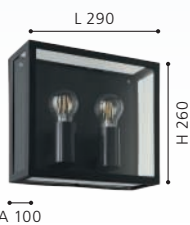

9 008606 255917

94832 ALAMONTE 1

wall/ceiling light; steel, black / glass, clear
Wand- / Deckenleuchte; Stahl, schwarz / Glas, klar
Applique/Plafonnier; acier, noir / verre, transparent

L 290, H 290, A 130



E27



2x 28W



IP44

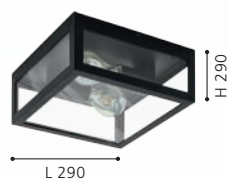

9 002759 948320

94832

This luminaire can be mounted as a wall or ceiling luminaire.

Diese Leuchten können als Wand- oder Deckenleuchte montiert werden.

Ce luminaire peut être monté en tant qu'applique murale ou plafonnier.



94788



94833



98713

HIGH
IP

94788 ALAMONTE 1

pendant light; steel, black / glass, clear
Hängeleuchte; Stahl, schwarz / Glas, klar
luminaire en suspension; acier, noir / verre, transparent

L 150, B 150, H 1285

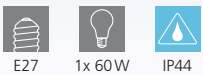

E27 1x 60W IP44



9 002759 947880



94833 ALAMONTE 1

floor light; steel, black / glass, clear
Stehleuchte; Stahl, schwarz / Glas, klar
lampadaire; acier, noir / verre, transparent

L 150, B 150, H 1015, Base: Ø 110

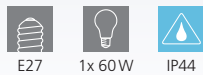

E27 1x 60W IP44



9 002759 948337



98713 CASCINETTA

wall light; zinc-plated steel, black / glass, clear
Wandleuchte; Stahl verzinkt, schwarz / Glas, klar
Applique; acier galvanisé, noir / verre, transparent

L 165, H 280, A 165



E27 1x 40W IP54



9 002759 987138





98715



98714



98715 CASCINETTA

floor light; cast aluminium, black / glass, clear
 Stehleuchte; Aluguss, schwarz / Glas, klar
 lampadaire; fonte d'aluminium, noir / verre, transparent

L 150, B 150, H 795



E27



1x 40W



IP54



9 002759 987152



L 150

98714 CASCINETTA

pedestal light; cast aluminium, black / glass, clear
 Sockelleuchte; Aluguss, schwarz / Glas, klar
 luminaire pour socle; fonte d'aluminium, noir / verre, transparent

L 150, B 150, H 305



E27



1x 40W



IP54



9 002759 987145



L 150

DESIGN
HIGHLIGHT
DETAIL



901034



901035



901034 SALLE

pedestal light; aluminium, plastic, black / plastic, black-transparent

Sockelleuchte; Alu, Kunststoff, schwarz / Kunststoff, schwarz-transparent

luminaire pour socle; aluminium, plastique, noir / plastique, noir transparent

H 465, Ø 75



901035 SALLE

floor light; aluminium, plastic, black / plastic, black-transparent

Stehleuchte; Alu, Kunststoff, schwarz / Kunststoff, schwarz-transparent

lampadaire; aluminium, plastique, noir / plastique, noir transparent

H 1100, Ø 75, Base: Ø 75



901033 SALLE

wall light; aluminium, plastic, black / plastic, black-transparent

Wandleuchte; Alu, Kunststoff, schwarz / Kunststoff, schwarz-transparent

Applique; aluminium, plastique, noir / plastique, noir transparent

H 310, Ø 75, A 105





901033





900986



120°, 6 m
10 sec. - 5 min.

**SAFETY &
COMFORT**



900985



120°, 6 m
10 sec. - 5
min.

**SAFETY &
COMFORT**



900987



120°, 6 m
10 sec. - 5
min.

**SAFETY &
COMFORT**

900986 HELSINKI

pedestal light; stainless steel, auburn / plastic, black-transparent
Sockelleuchte; Edelstahl, rostbraun / Kunststoff, schwarz-transparent

luminaire pour socle; acier inoxydable, brun rouille / plastique, noir transparent

H 450, Ø 75, Base: Ø 115



E27



1x 15 W



IP44



9 008606 298167

900985 HELSINKI

wall light; stainless steel, auburn / plastic, black-transparent
Wandleuchte; Edelstahl, rostbraun / Kunststoff, schwarz-transparent

Applique; acier inoxydable, brun rouille / plastique, noir transparent

H 400, Ø 75, A 165



E27



1x 15 W



IP44



9 008606 298150

900987 HELSINKI

floor light; stainless steel, auburn / plastic, black-transparent
Stehleuchte; Edelstahl, rostbraun / Kunststoff, schwarz-transparent

lampadaire; acier inoxydable, brun rouille / plastique, noir transparent

H 1100, Ø 75, Base: Ø 115



E27



1x 15 W



IP44

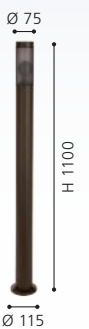

9 008606 298174

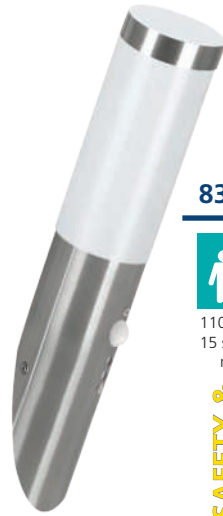

83278



110°, 5 m
15 sec. - 7
min.

**SAFETY &
COMFORT**



81751



81753



81751 HELSINKI

floor light; stainless steel, stainless steel / plastic, white
Stehleuchte; Edelstahl, edelstahl / Kunststoff, weiss
lampadaire; acier inoxydable, acier inoxydable / plastique, blanc

H 450, Ø 75, Base: Ø 115



E27 1x 12W IP65



9 002759 817510



83278 HELSINKI

wall light; stainless steel, stainless steel / plastic, white
Wandleuchte; Edelstahl, edelstahl / Kunststoff, weiss
Applique; acier inoxydable, acier inoxydable / plastique, blanc

H 425, Ø 75, A 165



E27 1x 12W IP44



9 002759 832780



81753 HELSINKI

wall light; stainless steel, stainless steel / plastic, white
Wandleuchte; Edelstahl, edelstahl / Kunststoff, weiss
Applique; acier inoxydable, acier inoxydable / plastique, blanc

H 390, Ø 75, A 165

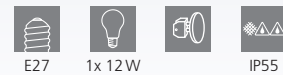

E27 1x 12W IP55



9 002759 817534

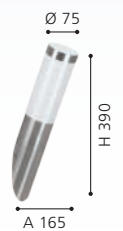



83279



110°, 5 m
15 sec. - 7
min.

**SAFETY &
COMFORT**



83281



110°, 5 m
15 sec. - 7
min.

**SAFETY &
COMFORT**



81752



**HIGH
IP**

83279 HELSINKI

floor light; stainless steel, stainless steel / plastic, white
Stehleuchte; Edelstahl, edelstahl / Kunststoff, weiss
lampadaire; acier inoxydable, acier inoxydable / plastique, blanc

H 450, Ø 75, Base: Ø 115



E27



1x 12 W



IP44

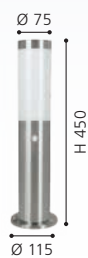

9 002759 832797

83281 HELSINKI

floor light; stainless steel, stainless steel / plastic, white
Stehleuchte; Edelstahl, edelstahl / Kunststoff, weiss
lampadaire; acier inoxydable, acier inoxydable / plastique, blanc

H 1100, Ø 75, Base: Ø 115



E27



1x 12 W



IP44



9 002759 832810

81752 HELSINKI

floor light; stainless steel, stainless steel / plastic, white
Stehleuchte; Edelstahl, edelstahl / Kunststoff, weiss
lampadaire; acier inoxydable, acier inoxydable / plastique, blanc

H 1100, Ø 75, Base: Ø 115



E27



1x 12 W



IP65

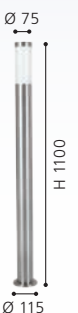

9 002759 817527



30205



DESIGN
HIGHLIGHT
DETAIL



30206

30205 NISIA

wall light; stainless steel, stainless steel / satin glass, white
Wandleuchte; Edelstahl, edelstahl / Glas satiniert, weiss
Applique; acier inoxydable, acier inoxydable / verre satiné, blanc

L 200, H 360, A 240

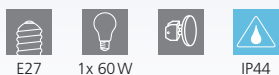

9 002759 302054



30206 NISIA

floor light; stainless steel, stainless steel / satin glass, white
Stehleuchte; Edelstahl, edelstahl / Glas satiniert, weiss
lampadaire; acier inoxydable, acier inoxydable / verre satiné, blanc

H 500, Ø 200, Base: Ø 130

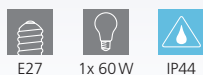

9 002759 302061



30207 NISIA

floor light; stainless steel, stainless steel / satin glass, white
Stehleuchte; Edelstahl, edelstahl / Glas satiniert, weiss
lampadaire; acier inoxydable, acier inoxydable / verre satiné, blanc

H 1000, Ø 200, Base: Ø 130

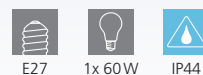

9 002759 302078





30207



98731



99572



99598

99572 RUBIO

wall light; cast aluminium, black / plastic, white
Wandleuchte; Aluguss, schwarz / Kunststoff, weiss
Applique; fonte d'aluminium, noir / plastique, blanc

L 170, H 150, A 190



98731 PRATA VECCHIA

wall light; zinc-plated steel, black / plastic, white
Wandleuchte; Stahl verzinkt, schwarz / Kunststoff, weiss
Applique; acier galvanisé, noir / plastique, blanc

L 200, H 260, A 285

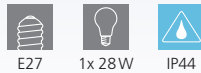

99598 TAVERNA

wall light; zinc-plated steel, black / plastic, transparent
Wandleuchte; Stahl verzinkt, schwarz / Kunststoff, transparent
Applique; acier galvanisé, noir / plastique, transparent

L 200, H 230, A 270

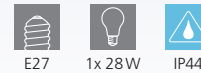

99586 & 99598

These luminaires can be mounted upwards or downwards.

Diese Leuchten können aufwärts oder abwärts montiert werden.

Ces luminaires peut être montée vers le haut ou vers le bas.



99586 TAVERNA

wall light; zinc-plated steel, black / plastic, black-transparent
Wandleuchte; Stahl verzinkt, schwarz / Kunststoff, schwarz-transparent

Applique; acier galvanisé, noir / plastique, noir transparent

L 200, H 230, A 255



E27



1x 28W



IP44





900278

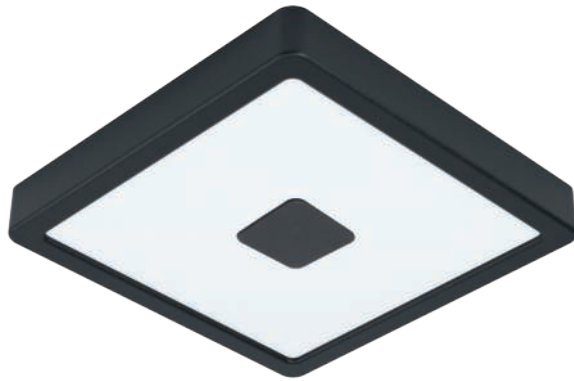

900283



900281



900278 ARGOLIS 2

surface-mounted light; steel, black / plastic, white
Aufbauleuchte; Stahl, schwarz / Kunststoff, weiss
luminaire en saillie; acier, noir / plastique, blanc

H 30, Ø 285



20,5W 2400lm

900281 ARGOLIS 2

surface-mounted light; steel, black / plastic, white
Aufbauleuchte; Stahl, schwarz / Kunststoff, weiss
luminaire en saillie; acier, noir / plastique, blanc

L 285, B 285, H 30



20,5W 2400lm

900283 IPHIAS 2

surface-mounted light; steel, black / plastic, white
Aufbauleuchte; Stahl, schwarz / Kunststoff, weiss
luminaire en saillie; acier, noir / plastique, blanc

L 210, B 210, H 30



17W 2000lm



9 008606 232635



9 008606 232659



9 008606 232611

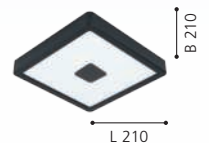



900277



900297



900279



900277 ARGOLIS 2

surface-mounted light; steel, white / plastic, white
Aufbauleuchte; Stahl, weiss / Kunststoff, weiss
luminaire en saillie; acier, blanc / plastique, blanc

H 30, Ø 285



20,5W



2400lm



IP44



900279 ARGOLIS 2

surface-mounted light; steel, white / plastic, white
Aufbauleuchte; Stahl, weiss / Kunststoff, weiss
luminaire en saillie; acier, blanc / plastique, blanc

L 285, B 285, H 30



20,5W



2400lm



IP44



900297 RONCO

wall/ceiling light; steel, white / plastic, white
Wand- / Deckenleuchte; Stahl, weiss / Kunststoff, weiss
Applique/Plafonnier; acier, blanc / plastique, blanc

H 55, Ø 220



7W



800lm



IP44



9 008606 232628



Ø 285



9 008606 232642



L 285



9 008606 231553



Ø 220





94871



97289



SAFETY & COMFORT



94872



3x 0-9 1x a-f

97289

Letters and numbers included in delivery.

Buchstaben und Zahlen im Lieferumfang enthalten.

Les lettres et les nombres sont inclus dans la livraison.

94871 SONELLA

wall/ceiling light; plastic, white / plastic, white
Wand- / Deckenleuchte; Kunststoff, weiss / Kunststoff, weiss
Applique/Plafonnier; plastique, blanc / plastique, blanc

L 215, H 215, A 70



8,2W 1000lm



9 002759 948719

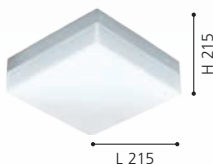

94872 SONELLA

wall/ceiling light; plastic, anthracite / plastic, white
Wand- / Deckenleuchte; Kunststoff, anthrazit / Kunststoff, weiss
Applique/Plafonnier; plastique, gris anthracite / plastique, blanc

L 215, H 215, A 70



8,2W 1000lm



9 002759 948726

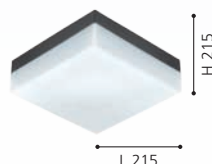

97289 CORNALE

wall light; plastic, anthracite / plastic, white
Wandleuchte; Kunststoff, anthrazit / Kunststoff, weiss
Applique; plastique, gris anthracite / plastique, blanc

L 215, H 215, A 70



1x 8,3W 950lm



9 002759 972899





97159



120°, 6 m
10 sec. - 8 min.

SAFETY &
COMFORT

97159 AZZINANO

wall light; zinc-plated steel, silver / plastic, white
Wandleuchte; Stahl verzinkt, silber / Kunststoff, weiss
Applique; acier galvanisé, argent / plastique, blanc

L 185, H 115, A 125



2x 5,6W 1400lm



IP44



9 002759 971595

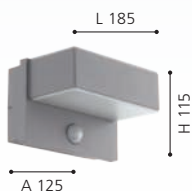



99584



120°, 6 m
5 sec. - 10 min.

**SAFETY &
COMFORT**



96365



98705



110°, 8 m
8 sec. - 5 min.

**SAFETY &
COMFORT**

99584 MADRIZ

wall light; cast aluminium, black / plastic, white
Wandleuchte; Aluguss, schwarz / Kunststoff, weiss
Applique; fonte d'aluminium, noir / plastique, blanc

L 230, H 190, A 50



2x 3,6W



740lm



IP44

98705 SALVANESCO

wall light; cast aluminium, black / plastic, white
Wandleuchte; Aluguss, schwarz / Kunststoff, weiss
Applique; fonte d'aluminium, noir / plastique, blanc

L 180, H 240, A 90



E27



1x 28W



IP44

96365 VENTO 2

wall/ceiling light; stainless steel, stainless steel / plastic, white
Wand- / Deckenleuchte; Edelstahl, edelstahl / Kunststoff, weiss
Applique/Plafonnier; acier inoxydable, acier inoxydable /
plastique, blanc

Ø 185, A 70



1x 5,4W



450lm



IP44



9 002759 995843



9 002759 987053



9 002759 963651





94121

LED

94121 VENTO 1

wall/ceiling light; stainless steel, stainless steel / glass, white painted

Wand- / Deckenleuchte; Edelstahl, edelstahl / Glas, weiss lackiert

Applique/Plafonnier; acier inoxydable, acier inoxydable / verre, blanc laqué

Ø 285, A 80



11 W



1300lm



IP44



9 002759 941215



Ø 285



94128



110°, 5 m
15 sec. - 7 min.

**SAFETY &
COMFORT**



86541



93268



94128 TRONO STICK

wall light; stainless steel, stainless steel / glass, plastic, clear
Wandleuchte; Edelstahl, edelstahl / Glas, Kunststoff, klar
Applique; acier inoxydable, acier inoxydable / verre, plastique, transparent

L 105, H 410, A 175



9 002759 941284



86541 BEVERLY

wall light; stainless steel, stainless steel, silver / satin glass, white
Wandleuchte; Edelstahl, edelstahl, silber / Glas satiniert, weiss
Applique; acier inoxydable, acier inoxydable, argent / verre satiné, blanc

L 200, H 350, A 135

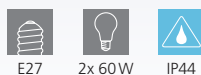

9 002759 865412



93268 STOCKHOLM 1

wall light; stainless steel, stainless steel / glass, clear
Wandleuchte; Edelstahl, edelstahl / Glas, klar
Applique; acier inoxydable, acier inoxydable / verre, transparent

Ø 100



9 002759 932688





94779

LED



96013

LED

94779 BOSARO

wall light; stainless steel, stainless steel
Wandleuchte; Edelstahl, edelstahl
Applique; acier inoxydable, acier inoxydable

L 170, H 270, A 105



2x 2,5W



460lm



IP44



9 002759 947798

96013 ROBLEDO

wall light; stainless steel, stainless steel / plastic, transparent
Wandleuchte; Edelstahl, edelstahl / Kunststoff, transparent
Applique; acier inoxydable, acier inoxydable / plastique, transparent

L 75, H 260, A 120



2x 3,7W



660lm



IP44



9 002759 960131



94107 RIGA

wall light; stainless steel, stainless steel
Wandleuchte; Edelstahl, edelstahl
Applique; acier inoxydable, acier inoxydable

94106 RIGA

wall light; stainless steel, stainless steel
Wandleuchte; Edelstahl, edelstahl
Applique; acier inoxydable, acier inoxydable

94103 RIGA

wall light; zinc-plated steel, anthracite
Wandleuchte; Stahl verzinkt, anthrazit
Applique; acier galvanisé, gris anthracite

L 65, H 200, A 95

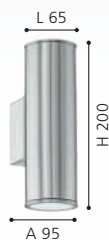
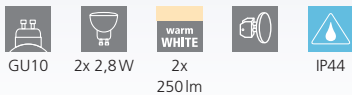

L 65, H 150, A 95



L 65, H 200, A 95

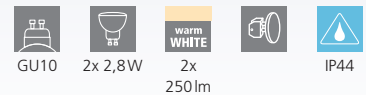



94105

LED



94101

LED



94102

LED

94105 RIGA

wall light; zinc-plated steel, antique brown
Wandleuchte; Stahl verzinkt, antik-braun
Applique; acier galvanisé, marron antique

L 65, H 200, A 95



GU10



2x 2,8W



warm
WHITE

2x
250lm



IP44



9 002759 941055



94102 RIGA

wall light; zinc-plated steel, anthracite
Wandleuchte; Stahl verzinkt, anthrazit
Applique; acier galvanisé, gris anthracite

L 65, H 150, A 95



GU10



1x 2,8W



warm
WHITE

1x
250lm



IP44



9 002759 941024



94101 RIGA

wall light; zinc-plated steel, white
Wandleuchte; Stahl verzinkt, weiss
Applique; acier galvanisé, blanc

L 65, H 200, A 95



GU10



2x 2,8W



warm
WHITE

2x
250lm



IP44



9 002759 941017





94804

LED



94803

LED



92736

LED

HIGH IP

94804 AGOLADA

wall light; zinc-plated steel, black, copper
Wandleuchte; Stahl verzinkt, schwarz, kupfer
Applique; acier galvanisé, noir, cuivre

L 75, H 360, A 110

LED

2x 3,7W

warm WHITE

660lm



IP44

L 75



A 110



9 002759 948047

94803 AGOLADA

wall light; stainless steel, stainless steel, white
Wandleuchte; Edelstahl, edelstahl, weiss
Applique; acier inoxydable, acier inoxydable, blanc

L 75, H 360, A 110

LED

2x 3,7W

warm WHITE

660lm



IP44

L 75



A 110



9 002759 948030

92736 RIGA-LED

wall light; stainless steel, stainless steel / plastic, satin finish
Wandleuchte; Edelstahl, edelstahl / Kunststoff, satiniert
Applique; acier inoxydable, acier inoxydable / plastique, satiné

L 65, H 205, A 95



GU10



2x 2,8W

neutral WHITE

2x 250lm



IP54

L 65



A 95



9 002759 927363



L 65



A 95



96505

LED

HIGH IP



97119

LED

96505 RIGA-LED

wall light; zinc-plated steel, black / plastic, satin finish
Wandleuchte; Stahl verzinkt, schwarz / Kunststoff, satiniert
Applique; acier galvanisé, noir / plastique, satiné

L 65, H 205, A 100



GU10



2x 4,6W



neutral
WHITE

2x
400lm



IP54



9 002759 965051



97119 TONEGO

wall light; zinc-plated steel, anthracite / plastic, white
Wandleuchte; Stahl verzinkt, anthrazit / Kunststoff, weiss
Applique; acier galvanisé, gris anthracite / plastique, blanc

L 75, H 310, A 100



LED
2x 6W



warm
WHITE
1200lm



IP44



IP44



9 002759 971199



99569



90°, 6 m
10 sec. - 12 min.

**SAFETY &
COMFORT**



99571



90°, 6 m
10 sec. - 12 min.

**SAFETY &
COMFORT**



99569 RIGA 5

wall light; stainless steel, stainless steel / glass, clear
Wandleuchte; Edelstahl, edelstahl / Glas, klar
Applique; acier inoxydable, acier inoxydable / verre, transparent

L 65, H 165, A 110



GU10



1x 2,8W



1x
250lm



IP44



99571 RIGA 5

wall light; zinc-plated steel, black / glass, clear
Wandleuchte; Stahl verzinkt, schwarz / Glas, klar
Applique; acier galvanisé, noir / verre, transparent

L 65, H 165, A 110



GU10



1x 2,8W



1x
250lm



IP44





32898



100°, 6 m
10 sec. - 12 min.

SAFETY & COMFORT



32899



100°, 6 m
10 sec. - 12 min.

SAFETY & COMFORT

32898 RIGA 5

wall light; stainless steel, stainless steel / glass, clear
Wandleuchte; Edelstahl, edelstahl / Glas, klar
Applique; acier inoxydable, acier inoxydable / verre, transparent

L 65, H 215, A 110



GU10



2x 2,8W



warm
WHITE
2x
250lm



IP44



9 002759 328986



32899 RIGA 5

wall light; zinc-plated steel, anthracite / glass, clear
Wandleuchte; Stahl verzinkt, anthrazit / Glas, klar
Applique; acier galvanisé, gris anthracite / verre, transparent

L 65, H 215, A 110



GU10



2x 2,8W



warm
WHITE
2x
250lm



IP44



9 002759 328993





96276



90°, 6 m
10 sec. - 12 min.

**SAFETY &
COMFORT**



96277



100°, 6 m
10 sec. - 12 min.

**SAFETY &
COMFORT**

96276 ATOLLARI

wall light; cast aluminium, anthracite / plastic, white
Wandleuchte; Aluguss, anthrazit / Kunststoff, weiss
Applique; fonte d'aluminium, gris anthracite / plastique, blanc

L 100, H 230, A 155



2x 4,9W



720lm



IP44



9 002759 962760

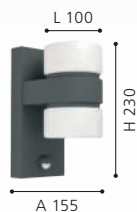

96277 ATOLLARI

wall light; cast aluminium, stainless steel, silver / plastic, white
Wandleuchte; Aluguss, edelstahl, silber / Kunststoff, weiss
Applique; fonte d'aluminium, acier inoxydable, argent / plastique, blanc

L 100, H 230, A 155



2x 4,9W



720lm



IP44



9 002759 962777

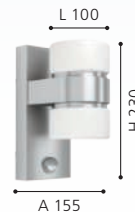



900284



98086



98085

900284 CISTIerna 2

wall light; steel, black / plastic, white
Wandleuchte; Stahl, schwarz / Kunststoff, weiss
Applique; acier, noir / plastique, blanc

L 130, H 350

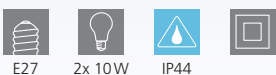

E27 2x 10W IP44



9 008606 231546



L 130

H 350

98086 CISTIerna

wall light; zinc-plated steel, anthracite / plastic, white
Wandleuchte; Stahl verzinkt, anthrazit / Kunststoff, weiss
Applique; acier galvanisé, gris anthracite / plastique, blanc

L 180, H 350, A 90



E27 2x 10W IP44



9 002759 980863



L 180

H 350

A 90

98085 CISTIerna

wall light; stainless steel, stainless steel / plastic, white
Wandleuchte; Edelstahl, edelstahl / Kunststoff, weiss
Applique; acier inoxydable, acier inoxydable / plastique, blanc

L 180, H 350, A 90



E27 2x 10W IP44



9 002759 980856



L 180

H 350

A 90



96287



100°, 6 m
10 sec. - 12 min.

SAFETY & COMFORT



96256



96287 SAKEDA

wall light; cast aluminium, anthracite
Wandleuchte; Aluguss, anthrazit
Applique; fonte d'aluminium, gris anthracite

L 70, H 170, A 100



1x 5W 600lm



96256 JORBA

wall light; cast aluminium, anthracite / plastic, white
Wandleuchte; Aluguss, anthrazit / Kunststoff, weiss
Applique; fonte d'aluminium, gris anthracite / plastique, blanc

L 110, H 110, A 110



1x 4,9W 360lm



95097 DESELLA 1

wall light; cast aluminium, anthracite / plastic, white
Wandleuchte; Aluguss, anthrazit / Kunststoff, weiss
Applique; fonte d'aluminium, gris anthracite / plastique, blanc

L 160, H 160, A 190



10W 1200lm

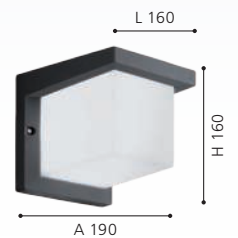



95097

LED

HIGH
IP





901026



901025



GRUTTI

CCT Dipswitch on the back.
CCT Dip-Schalter auf Rückseite.
CCT Dipwitch à l'arrière.

901026 GRUTTI

wall light; aluminium, anthracite / plastic, transparent
Wandleuchte; Alu, anthrazit / Kunststoff, transparent
Applique; aluminium, gris anthracite / plastique, transparent

L 175, H 90, A 50



2x 5,8W



1260lm



IP65



901025 GRUTTI

wall light; aluminium, anthracite / plastic, transparent
Wandleuchte; Alu, anthrazit / Kunststoff, transparent
Applique; aluminium, gris anthracite / plastique, transparent

L 115, H 90, A 50



2x 2,9W



640lm



IP65



9 008606 298129

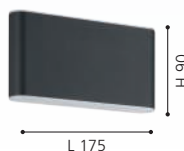

9 008606 298112

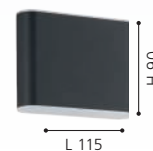



900189



900276



900275



900189 EREMITANA

wall light; zinc-plated steel, black
Wandleuchte; Stahl verzinkt, schwarz
Applique; acier galvanisé, noir

L 110, H 240, A 110

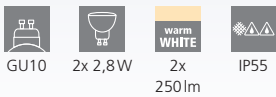

9 008606 234264



900275 JABAGA

wall light; plastic, black / plastic, transparent
Wandleuchte; Kunststoff, schwarz / Kunststoff, transparent
Applique; plastique, noir / plastique, transparent

L 70, H 80, A 90



9 008606 261796



900276 JABAGA

wall light; plastic, black / plastic, transparent
Wandleuchte; Kunststoff, schwarz / Kunststoff, transparent
Applique; plastique, noir / plastique, transparent

L 70, H 155, A 90



9 008606 261802





900996

LED



900995

LED



DESIGN
HIGHLIGHT
DETAIL

900996 IZZALINI

floor light; steel, black
Stehleuchte; Stahl, schwarz
lampadaire; acier, noir

L 65, H 850, Base: Ø 110



GU10



1x 2,8W



1x
warm
WHITE
250lm



IP44



9 008606 298211



INCL.

900995 IZZALINI

wall light; steel, black
Wandleuchte; Stahl, schwarz
Applique; acier, noir

L 65, H 115, A 95



GU10



1x 2,8W



1x
warm
WHITE
250lm



IP44



Ø 110



9 008606 298204



INCL.

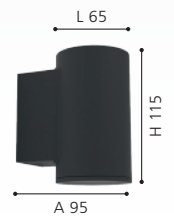

A 95

901028



901029



901029 TORRECOLA

ceiling light; aluminium, plastic, black / glass, clear
Deckenleuchte; Alu, Kunststoff, schwarz / Glas, klar
plafonnier; aluminium, plastique, noir / verre, transparent

L 80, B 80, H 95



GU10



1x 5W



IP44



901028 TORRECOLA

ceiling light; aluminium, plastic, black / glass, clear
Deckenleuchte; Alu, Kunststoff, schwarz / Glas, klar
plafonnier; aluminium, plastique, noir / verre, transparent

H 95, Ø 80



GU10



1x 5W



IP44



9 008606 298143

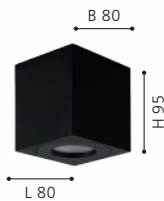

9 008606 298136





900885



900886



900887



900885 SPONGANO

wall light; aluminium, black / glass, clear
Wandleuchte; Alu, schwarz / Glas, klar
Applique; aluminium, noir / verre, transparent

900886 SPONGANO

wall light; aluminium, black / plastic, transparent
Wandleuchte; Alu, schwarz / Kunststoff, transparent
Applique; aluminium, noir / plastique, transparent

900887 SPONGANO

wall light; aluminium, black / plastic, transparent
Wandleuchte; Alu, schwarz / Kunststoff, transparent
Applique; aluminium, noir / plastique, transparent

L 185, H 90, A 75



2x 5W



1200lm



IP65

L 120, H 200, A 60



2x 5W



1200lm



IP65

L 200, H 120, A 60



1x 9,5W



1100lm



IP65



9 008606 263981



L 185

H 90



9 008606 263998



L 120

H 200



9 008606 264001



L 200

H 120



900888



900889



900891



SPONGANO, MARUGGIO

These luminaires can be set via step dimming change the light settings from 3000K, 4000K, 5000K to 6500 Kelvin.

Diese Leuchten können über Stepdimming die Lichteinstellungen von 3000K, 4000K, 5000K zu 6500 Kelvin wechseln.

Ces luminaires peuvent être commandés par stepdimming les réglages de lumière de 3000K, 4000K, 5000K à 6500 Kelvin.

900888 MARUGGIO

wall light; aluminium, black / plastic, transparent
Wandleuchte; Alu, schwarz / Kunststoff, transparent
Applique; aluminium, noir / plastique, transparent

Ø 150, A 35

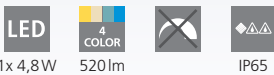

1x 4,8W 520lm

900891 MARUGGIO

wall light; aluminium, black / plastic, transparent
Wandleuchte; Alu, schwarz / Kunststoff, transparent
Applique; aluminium, noir / plastique, transparent

L 200, H 90, A 35

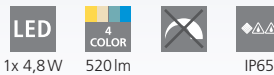

1x 4,8W 520lm

900889 MARUGGIO

wall light; aluminium, black / plastic, transparent
Wandleuchte; Alu, schwarz / Kunststoff, transparent
Applique; aluminium, noir / plastique, transparent

L 150, H 150, A 35

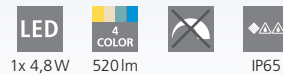

1x 4,8W 520lm



9 008606 264018



Ø 150



9 008606 264032



L 200



9 008606 264025



L 150



900445

This wall luminaire creates beautiful stripe pattern on the wall.

Diese Wandleuchten kreieren schöne Streifen an der Wand.

Ces appliques murales créent de belles rayures sur le mur.



97241



900445



97242



97241, 97242

These wall lights have adjustable flaps.

Diese Wandleuchten besitzen vertstellbare Klappen.

Ces appliques murales possèdent des volets réglables.

900445 CALPINO 2

wall light; cast aluminium, anthracite
Wandleuchte; Aluguss, anthrazit
Applique; fonte d'aluminium, gris anthracite

L 105, H 105, A 110



2x 3,3W 680lm



9 008606 253067

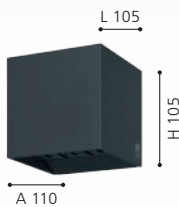

97241 CALPINO

wall light; cast aluminium, white
Wandleuchte; Aluguss, weiss
Applique; fonte d'aluminium, blanc

L 105, H 105, A 110



2x 3,3W 680lm



9 002759 972417

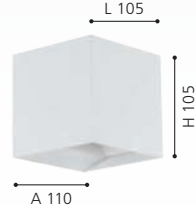

97242 CALPINO

wall light; cast aluminium, anthracite
Wandleuchte; Aluguss, anthrazit
Applique; fonte d'aluminium, gris anthracite

L 105, H 105, A 110



2x 3,3W 680lm



9 002759 972424

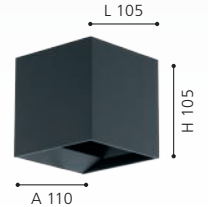



900292

LED

900292 LESMO

wall light; cast aluminium, black / glass, clear

Wandleuchte; Aluguss, schwarz / Glas, klar

Applique; fonte d'aluminium, noir / verre, transparent

L 240, H 105, A 115



4x 2,8W



1560lm



IP44

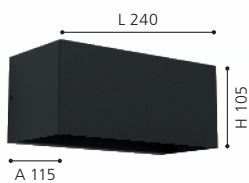



901064



CALPINO 3

The adjustable flaps in the luminaires allow individualised lighting scenarios to be set.

Durch die verstellbaren Klappen in der Leuchten können individuell Lichtszenarien eingestellt werden.

Les volets réglables dans les luminaires permettent de définir des scénarios d'éclairage individualisés.

901064 CALPINO 3

wall light; cast aluminium, black / glass, clear

Wandleuchte; Aluguss, schwarz / Glas, klar

Applique; fonte d'aluminium, noir / verre, transparent

L 100, H 100, A 100



2x 2,8W



840lm



IP54



9 008606 297665

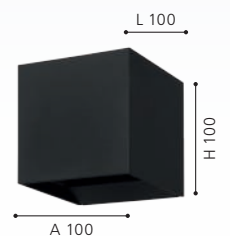



901063

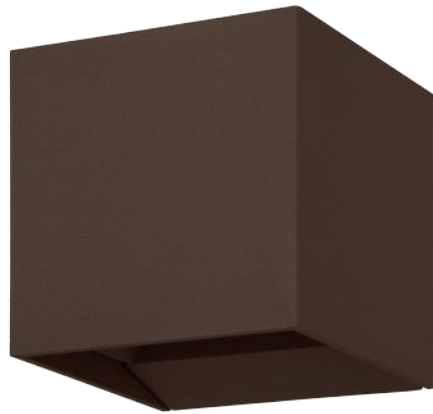

901066



901065



901063 CALPINO 3

wall light; cast aluminium, white / glass, clear
Wandleuchte; Aluguss, weiss / Glas, klar
Applique; fonte d'aluminium, blanc / verre, transparent

L 100, H 100, A 100

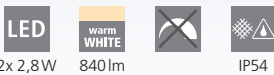

2x 2,8W 840lm

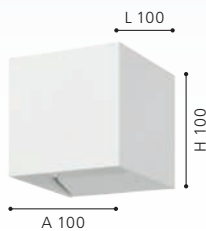

901065 CALPINO 3

wall light; cast aluminium, anthracite / glass, clear
Wandleuchte; Aluguss, anthrazit / Glas, klar
Applique; fonte d'aluminium, gris anthracite / verre, transparent

L 100, H 100, A 100



2x 2,8W 840lm

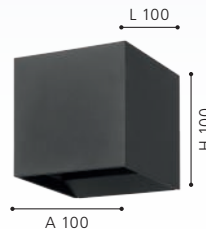

901066 CALPINO 3

wall light; cast aluminium, auburn / glass, clear
Wandleuchte; Aluguss, rostbraun / Glas, klar
Applique; fonte d'aluminium, brun rouille / verre, transparent

L 100, H 100, A 100



2x 2,8W 840lm

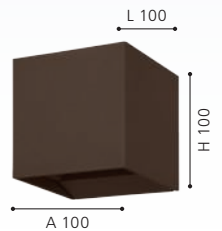



900807



900809

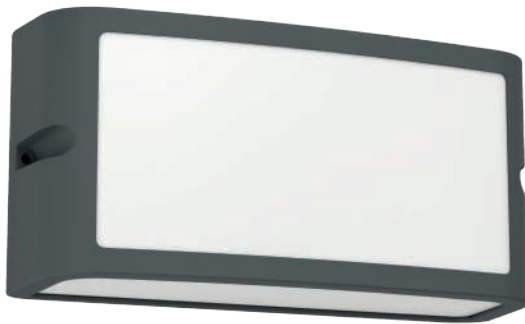

900808



900807 CAMARDA

wall light; aluminium, white / plastic, white
Wandleuchte; Alu, weiss / Kunststoff, weiss
Applique; aluminium, blanc / plastique, blanc

L 220, H 110, A 90



10,5W



1200lm



IP54



9 008606 261895

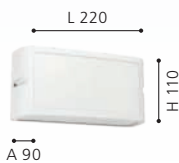

900808 CAMARDA

wall light; aluminium, anthracite / plastic, white
Wandleuchte; Alu, anthrazit / Kunststoff, weiss
Applique; aluminium, gris anthracite / plastique, blanc

L 220, H 110, A 90



10,5W



1200lm



IP54



9 008606 261901



900809 CAMARDA

wall light; aluminium, white / plastic, white
Wandleuchte; Alu, weiss / Kunststoff, weiss
Applique; aluminium, blanc / plastique, blanc

L 220, H 110, A 90



E27



1x 40W



IP54



9 008606 261918

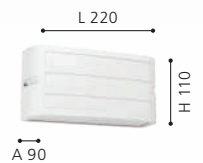



900811



900811 CAMARDA

wall light; aluminium, anthracite / plastic, white

Wandleuchte; Alu, anthrazit / Kunststoff, weiss

Applique; aluminium, gris anthracite / plastique, blanc

L 220, H 110, A 90



E27



1x 40 W



IP54



9 008606 261925

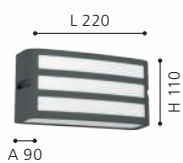



99521



105°, 6 m
5 sec. - 10 min.

**SAFETY &
COMFORT**



97218



180°, 7 m
10 sec. - 15 min.

SAFETY & COMFORT



97238



90°, 7 m
10 sec. - 4 min.

SAFETY & COMFORT

99521 CASAZZA

wall light; zinc-plated steel, black / plastic, white
Wandleuchte; Stahl verzinkt, schwarz / Kunststoff, weiss
Applique; acier galvanisé, noir / plastique, blanc

L 200, H 400, A 80



16W



2350lm



IP44



9 002759 995218

97218 MUSSOTTO

wall light; stainless steel, plastic, stainless steel, white / plastic, white

Wandleuchte; Edelstahl, Kunststoff, edelstahl, weiss / Kunststoff, weiss

Applique; acier inoxydable, plastique, acier inoxydable, blanc / plastique, blanc

L 210, H 305, A 90



E27



1x 28W



IP44



9 002759 972189

97238 VERRES

wall light; stainless steel, plastic, stainless steel, white / plastic, white

Wandleuchte; Edelstahl, Kunststoff, edelstahl, weiss / Kunststoff, weiss

Applique; acier inoxydable, plastique, acier inoxydable, blanc / plastique, blanc

L 180, H 290, A 90



E27



1x 12W



IP44



9 002759 972387



96018



90°, 6 m
10 sec. - 10 min.

**SAFETY &
COMFORT**



94138

LED



83433

96018 BREGANZO 1

wall light; zinc-plated steel, anthracite / plastic, white
Wandleuchte; Stahl verzinkt, anthrazit / Kunststoff, weiss
Applique; acier galvanisé, gris anthracite / plastique, blanc

L 190, H 300, A 125



2x 2,5W



460lm



IP44



9 002759 960186



94138 BREGANZO

wall light; zinc-plated steel, anthracite / plastic, white
Wandleuchte; Stahl verzinkt, anthrazit / Kunststoff, weiss
Applique; acier galvanisé, gris anthracite / plastique, blanc

L 180, H 250, A 115



2x 2,5W



460lm



IP44



9 002759 941383

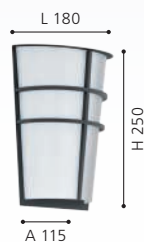

83433 PARK

wall light; cast aluminium, anthracite / satin glass, white
Wandleuchte; Aluguss, anthrazit / Glas satiniert, weiss
Applique; fonte d'aluminium, gris anthracite / verre satiné, blanc

L 200, H 350, A 145



E27



1x 60W



IP44



9 002759 834333





97284



180°, 6 m
10 sec. - 15 min.

**SAFETY &
COMFORT**



30191

97284 TRIBANO

wall light; zinc-plated steel, stainless steel / plastic, transparent
Wandleuchte; Stahl verzinkt, edelstahl / Kunststoff, transparent
Applique; acier galvanisé, acier inoxydable / plastique, transparent

L 200, H 260, A 100



E27



1x 60W



IP44



L 200



A 100



9 002759 972844

30191 CERNO

wall light; stainless steel, stainless steel / satin glass, white
Wandleuchte; Edelstahl, edelstahl / Glas satiniert, weiss
Applique; acier inoxydable, acier inoxydable / verre satiné, blanc

L 140, H 165, A 105



E27



1x 40W



IP44

L 140



A 105



9 002759 301910



99565



30192



90°, 7 m
10 sec. - 4 min.

**SAFETY &
COMFORT**



99566



90°, 6 m
5 sec. - 5 min.

**SAFETY &
COMFORT**

30192 CERNO

wall light; stainless steel, stainless steel / satin glass, white
Wandleuchte; Edelstahl, edelstahl / Glas satiniert, weiss
Applique; acier inoxydable, acier inoxydable / verre satiné, blanc

L 140, H 190, A 110



E27



1x 40 W



IP44



9 002759 301927

99565 CERNO

wall light; zinc-plated steel, black / satin glass, white
Wandleuchte; Stahl verzinkt, schwarz / Glas satiniert, weiss
Applique; acier galvanisé, noir / verre satiné, blanc

L 140, H 165, A 105



E27



1x 40 W



IP44



9 002759 995652

99566 CERNO

wall light; zinc-plated steel, black / satin glass, white
Wandleuchte; Stahl verzinkt, schwarz / Glas satiniert, weiss
Applique; acier galvanisé, noir / verre satiné, blanc

L 140, H 200, A 110



E27



1x 40 W



IP44



9 002759 995669



82309



88144



90°, 7 m
10 sec. - 5 min.

**SAFETY &
COMFORT**



88142



90°, 7 m
10 sec. - 5 min.

**SAFETY &
COMFORT**

88144 CITY

wall light; stainless steel, stainless steel / plastic, white
Wandleuchte; Edelstahl, edelstahl / Kunststoff, weiss
Applique; acier inoxydable, acier inoxydable / plastique, blanc

L 235, H 260, A 90



E27 1x 60W

IP44



9 002759 881443

82309 CITY

wall light; stainless steel, stainless steel / plastic, white
Wandleuchte; Edelstahl, edelstahl / Kunststoff, weiss
Applique; acier inoxydable, acier inoxydable / plastique, blanc

L 235, H 260, A 90

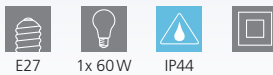

E27 1x 60W

IP44



9 002759 823092

88142 CITY

wall light; stainless steel, stainless steel / plastic, white
Wandleuchte; Edelstahl, edelstahl / Kunststoff, weiss
Applique; acier inoxydable, acier inoxydable / plastique, blanc

L 235, H 260, A 90



E27 1x 60W

IP44



9 002759 881429



99568



90°, 7 m
10 sec. - 5 min.

**SAFETY &
COMFORT**



88139



99567

88139 CITY

wall light; stainless steel, stainless steel / plastic, white
Wandleuchte; Edelstahl, edelstahl / Kunststoff, weiss
Applique; acier inoxydable, acier inoxydable / plastique, blanc

L 235, H 260, A 90

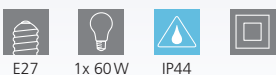

E27

1x 60W

IP44



9 002759 881399

99568 CITY

wall light; zinc-plated steel, black / plastic, white
Wandleuchte; Stahl verzinkt, schwarz / Kunststoff, weiss
Applique; acier galvanisé, noir / plastique, blanc

L 235, H 260, A 110



E27

1x 40W

IP44



9 002759 995683

99567 CITY

wall light; zinc-plated steel, black / plastic, white
Wandleuchte; Stahl verzinkt, schwarz / Kunststoff, weiss
Applique; acier galvanisé, noir / plastique, blanc

L 235, H 260, A 90



E27

1x 40W

IP44



9 002759 995676



TRADITIONAL

TRADITIONELL
TRADITIONNELLE



EN **TRADITIONAL ELEGANCE**

Romantic elements made of different materials create an inviting atmosphere that brings the beauty of the past into your surroundings.

DE **TRADITIONELLE ELEGANZ**

Romantische Elemente aus unterschiedlichen Materialien schaffen eine einladende Atmosphäre, die die Schönheit der Vergangenheit in Ihre Umgebung bringt.

FR **ÉLÉGANCE TRADITIONNELLE**

Des éléments romantiques composés de différents matériaux créent une atmosphère accueillante qui apporte la beauté du passé dans votre environnement.





OVERVIEW

TRADITIONAL
TRADITIONELL
TRADITIONNELLE



DONATORI
144



SIRMIONE
146



SIDNEY
147



LISIO
148-149



CARRARO
150



SONCINO
151



MIRANDOLA
151



PULFERO
152



CANOVE
152



MELGOA
152, 156



HILBURN
154



HILBURN 1
154



MILTON
154, 156



BARROSELA
156



PULFERO 1
158



VALDEO
158, 160



ALBACETE
158



SAN TELMO
159



BOVOLONE
160



TRECATE
160



MONREALE
161



ALORIA
162-164



NAVEDO
166-171



LATERNA 4
172-173, 176



LATERNA 5
174, 177



ONJA
178



This product is available in different colors and shapes./
Dieser Artikel ist in unterschiedlichen Farben und Formen verfügbar.
Cet article est disponible en différentes couleurs et formes.



DESIGN
HIGHLIGHT
DETAIL



98702



98703

98702 DONATORI

pedestal light; cast aluminium, black / glass, clear
Sockelleuchte; Aluguss, schwarz / Glas, klar
luminaire pour socle; fonte d'aluminium, noir / verre, transparent

H 310, Ø 155, Base: Ø 130



E27 1x 60W IP44



9 002759 987022



98703 DONATORI

floor light; cast aluminium, black / glass, clear
Stehleuchte; Aluguss, schwarz / Glas, klar
lampadaire; fonte d'aluminium, noir / verre, transparent

H 990, Ø 155, Base: Ø 130

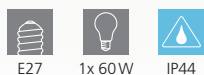

E27 1x 60W IP44



9 002759 987039



98701 DONATORI

wall light; aluminium, plastic, black / glass, clear
Wandleuchte; Alu, Kunststoff, schwarz / Glas, klar
Applique; aluminium, plastique, noir / verre, transparent

L 155, H 260, A 190

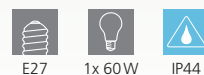

E27 1x 60W IP44



9 002759 987015





98701





97285

97287

97288

97285 SIRMIONE

wall light; zinc-plated steel, black, gold / matte-opal glass, white
Wandleuchte; Stahl verzinkt, schwarz, gold / Glas opal-matt, weiss
Applique; acier galvanisé, noir, or / verre opale mat, blanc

L 270, H 375, A 330



97287 SIRMIONE

floor light; zinc-plated steel, black, gold / matte-opal glass, white
Stehleuchte; Stahl verzinkt, schwarz, gold / Glas opal-matt, weiss
lampadaire; acier galvanisé, noir, or / verre opale mat, blanc

L 340, B 270, H 1200, Base: Ø 110

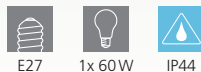

97288 SIRMIONE

floor light; zinc-plated steel, black, gold / matte-opal glass, white
Stehleuchte; Stahl verzinkt, schwarz, gold / Glas opal-matt, weiss
lampadaire; acier galvanisé, noir, or / verre opale mat, blanc

H 2200, Ø 550, Base: Ø 200

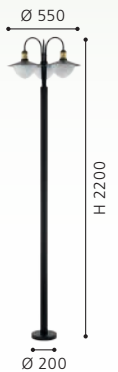



83966



87105



120°, 6 m
5 sec. - 8 min.

SAFETY &
COMFORT



83971

83966 SIDNEY

wall light; stainless steel, stainless steel / matte-opal glass, white
Wandleuchte; Edelstahl, edelstahl / Glas opal-matt, weiss
Applique; acier inoxydable, acier inoxydable / verre opale mat, blanc

H 375, Ø 270, A 325



E27

1x 60W

IP44



9 002759 839666

87105 SIDNEY

wall light; stainless steel, stainless steel / matte-opal glass, white
Wandleuchte; Edelstahl, edelstahl / Glas opal-matt, weiss
Applique; acier inoxydable, acier inoxydable / verre opale mat, blanc

H 375, Ø 270, A 325



E27

1x 60W

IP44



9 002759 871055

83971 SIDNEY

floor light; stainless steel, stainless steel / matte-opal glass, white
Stehleuchte; Edelstahl, edelstahl / Glas opal-matt, weiss
lampadaire; acier inoxydable, acier inoxydable / verre opale mat, blanc

H 2200, Ø 600, Base: Ø 200



E27

3x 60W

IP44

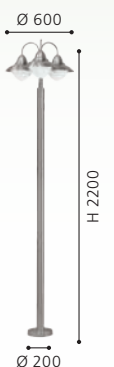

9 002759 839710



30184

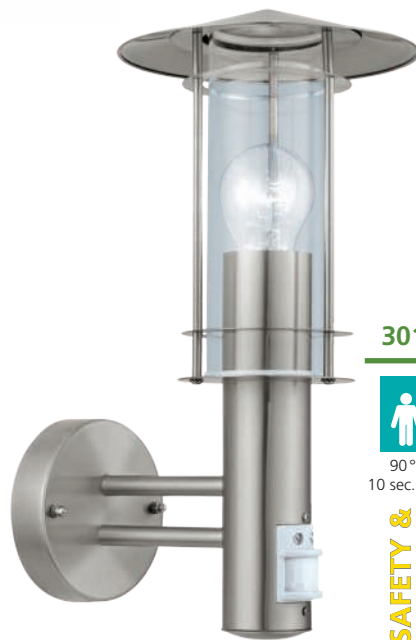

30185



90°, 8 m
10 sec. - 4 min.

**SAFETY &
COMFORT**

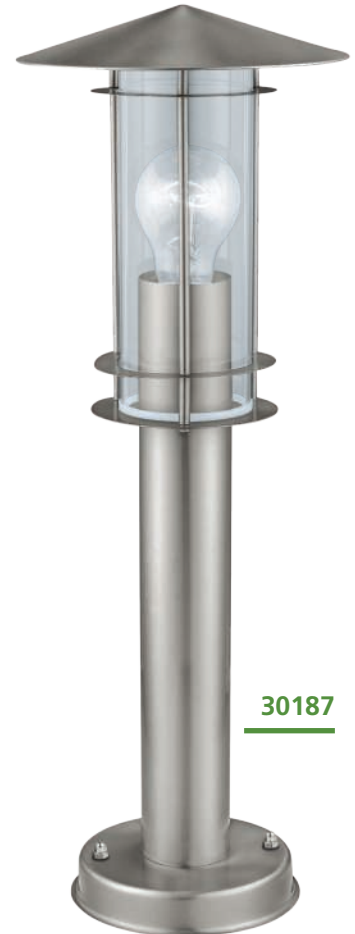

30187

30184 LISIO

wall light; stainless steel, stainless steel / glass, clear
Wandleuchte; Edelstahl, edelstahl / Glas, klar
Applique; acier inoxydable, acier inoxydable / verre, transparent

L 175, H 300, A 225



9 002759 301842



30185 LISIO

wall light; stainless steel, stainless steel / glass, clear
Wandleuchte; Edelstahl, edelstahl / Glas, klar
Applique; acier inoxydable, acier inoxydable / verre, transparent

L 175, H 360, A 225



9 002759 301859



30187 LISIO

floor light; stainless steel, stainless steel / glass, clear
Stehleuchte; Edelstahl, edelstahl / Glas, klar
lampadaire; acier inoxydable, acier inoxydable / verre, transparent

H 500, Ø 175, Base: Ø 130



9 002759 301873

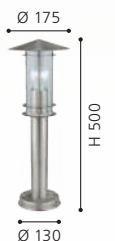



30188

30188 LISIO

floor light; stainless steel, stainless steel / glass, clear

Stehleuchte; Edelstahl, edelstahl / Glas, klar

lampadaire; acier inoxydable, acier inoxydable / verre, transparent

H 1000, Ø 175, Base: Ø 130



E27



1x 60W



IP44



9 002759 301880



900285



900286

DESIGN
HIGHLIGHT
DETAIL



900285 CARRARO

wall light; steel, black / glass, clear
Wandleuchte; Stahl, schwarz / Glas, klar
Applique; acier, noir / verre, transparent

L 115, H 380, A 130



E27



1x 28W



IP44



9 008606 231577



900286 CARRARO

wall light; steel, grey, black / glass, clear
Wandleuchte; Stahl, grau, schwarz / Glas, klar
Applique; acier, gris, noir / verre, transparent

L 115, H 380, A 130



E27



1x 28W



IP44



9 008606 231584





97294



98719

97294 SONCINO

wall light; cast aluminium, black / glass, clear
 Wandleuchte; Aluguss, schwarz / Glas, klar
 Applique; fonte d'aluminium, noir / verre, transparent

L 265, H 330, A 120

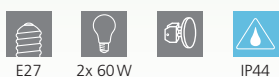

98719 MIRANDOLA

wall light; cast aluminium, black / glass, clear
 Wandleuchte; Aluguss, schwarz / Glas, klar
 Applique; fonte d'aluminium, noir / verre, transparent

L 180, H 270, A 225

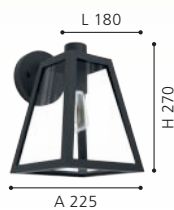
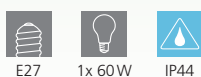



97226



94841

94841 PULFERO

wall light; zinc-plated steel, black / plastic, transparent
Wandleuchte; Stahl verzinkt, schwarz / Kunststoff, transparent
Applique; acier galvanisé, noir / plastique, transparent

L 220, H 280, A 280



9 002759 948412



97226 CANOVE

wall light; zinc-plated steel, black / glass, clear, satin finish
Wandleuchte; Stahl verzinkt, schwarz / Glas, klar, satiniert
Applique; acier galvanisé, noir / verre, transparent, satiné

L 230, H 240, A 235

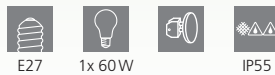

9 002759 972264

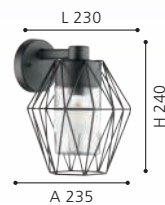

94792 MELGOA

wall light; zinc-plated steel, black / glass, clear
Wandleuchte; Stahl verzinkt, schwarz / Glas, klar
Applique; acier galvanisé, noir / verre, transparent

L 300, H 250, A 380

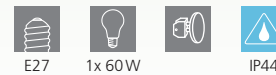

9 002759 947927





94792



94843

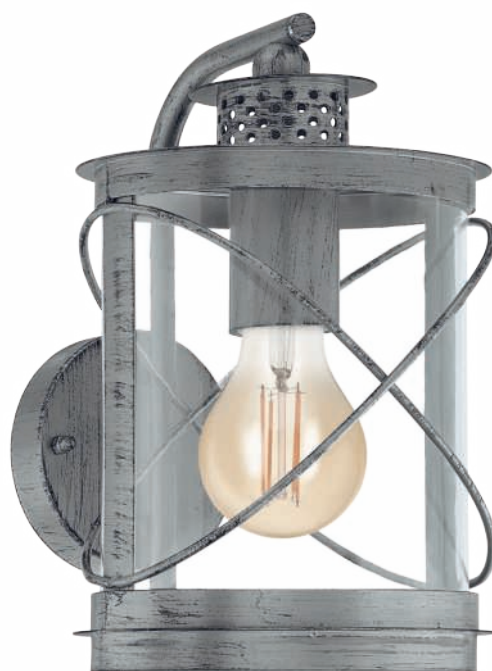

94866

94843 HILBURN

wall light; zinc-plated steel, black / plastic, transparent
 Wandleuchte; Stahl verzinkt, schwarz / Kunststoff, transparent
 Applique; acier galvanisé, noir / plastique, transparent

L 200, H 280, A 200



94866 HILBURN 1

wall light; zinc-plated steel, antique silver / plastic, transparent
 Wandleuchte; Stahl verzinkt, silber-antik / Kunststoff, transparent
 Applique; acier galvanisé, argent antique / plastique, transparent

L 200, H 280, A 200



88489 MILTON

wall light; steel, zinc-plated / glass, clear
 Wandleuchte; Stahl, feuerverzinkt / Glas, klar
 Applique; acier, galvanisé à chaud / verre, transparent

H 310, A 310



9 002759 948436



9 002759 948665

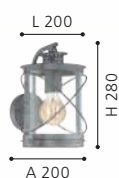

9 002759 884895





88489



94863



94858

94863 MELGOA

wall light; zinc-plated steel, antique copper coloured / glass, clear

Wandleuchte; Stahl verzinkt, kupferfarben-antik / Glas, klar

Applique; acier galvanisé, cuivré antique / verre, transparent

L 300, H 250, A 380



E27 1x 60W IP44



9 002759 948634

94858 BARROSELA

wall light; zinc-plated steel, antique copper coloured / plastic, white

Wandleuchte; Stahl verzinkt, kupferfarben-antik / Kunststoff, weiss

Applique; acier galvanisé, cuivré antique / plastique, blanc

L 220, H 240, A 230

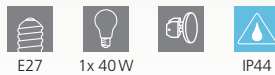

E27 1x 40W IP44



9 002759 948580

83589 MILTON

wall light; zinc-plated steel, antique brown / glass, clear

Wandleuchte; Stahl verzinkt, antik-braun / Glas, klar

Applique; acier galvanisé, marron antique / verre, transparent

B 240, H 310, A 300

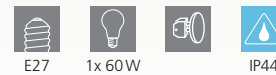

E27 1x 60W IP44



9 002759 835897



83589



94855



96241

94855 PULFERO 1

wall light; zinc-plated steel, brown / plastic, transparent
Wandleuchte; Stahl verzinkt, braun / Kunststoff, transparent
Applique; acier galvanisé, marron / plastique, transparent

L 220, H 280, A 280



9 002759 948559



96241 VALDEO

wall light; zinc-plated steel, antique copper coloured / glass, clear
Wandleuchte; Stahl verzinkt, kupferfarben-antik / Glas, klar
Applique; acier galvanisé, cuivré antique / verre, transparent

L 165, H 275, A 200

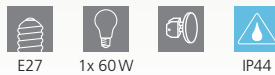

9 002759 962418



96262 ALBACETE

wall light; zinc-plated steel, brown, copper / glass with air bubbles, clear
Wandleuchte; Stahl verzinkt, braun, kupfer / Glas mit Lufteinschlüssen, klar
Applique; acier galvanisé, marron, cuivre / verre avec bulles d'air, transparent

L 265, H 255, A 280



9 002759 962623





96262

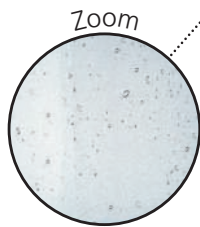

90184

90184 SAN TELMO

wall light; zinc-plated steel, cast alumin, antique brown / glass with air bubbles, clear

Wandleuchte; Stahl verzinkt, Aluguss, antik-braun / Glas mit Lufteinschlüssen, klar

Applique; acier galvanisé, fonte d'alumi, marron antique / verre avec bulles d'air, transparent

L 180, H 350, A 240



E27



1x 60 W



IP23



L 180



A 240

H 350



9 002759 901844





97261



97296



96239

97261 BOVOLONE

wall light; zinc-plated steel, black / glass, clear
Wandleuchte; Stahl verzinkt, schwarz / Glas, klar
Applique; acier galvanisé, noir / verre, transparent

L 110, H 340, A 155



9 002759 972615



96239 VALDEO

wall light; zinc-plated steel, black / glass, clear
Wandleuchte; Stahl verzinkt, schwarz / Glas, klar
Applique; acier galvanisé, noir / verre, transparent

L 165, H 275, A 200

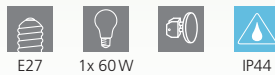

9 002759 962395



97296 TRECATE

wall light; zinc-plated steel, black / glass, clear
Wandleuchte; Stahl verzinkt, schwarz / Glas, klar
Applique; acier galvanisé, noir / verre, transparent

L 160, H 355, A 130

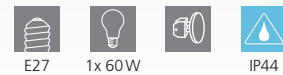

9 002759 972967





98121



98123

98121 MONREALE

wall light; cast aluminium, black / plastic, transparent
 Wandleuchte; Aluguss, schwarz / Kunststoff, transparent
 Applique; fonte d'aluminium, noir / plastique, transparent

L 230, H 275, A 255



E27



1x 60 W



IP44



9 002759 981211

98123 MONREALE

floor light; cast aluminium, black / plastic, transparent
 Stehleuchte; Aluguss, schwarz / Kunststoff, transparent
 lampadaire; fonte d'aluminium, noir / plastique, transparent

H 995, Ø 230, Base: Ø 110



E27



1x 60 W



IP44



9 002759 981235





93097



93407



93098

93097 ALORIA

wall light; cast aluminium, black / plastic, clear
Wandleuchte; Aluguss, schwarz / Kunststoff, klar
Applique; fonte d'aluminium, noir / plastique, transparent

L 170, H 225, A 190



9 002759 930974



93098 ALORIA

wall light; cast aluminium, black / plastic, clear
Wandleuchte; Aluguss, schwarz / Kunststoff, klar
Applique; fonte d'aluminium, noir / plastique, transparent

L 170, H 225, A 190



9 002759 930981



93407 ALORIA

wall light; cast aluminium, black / plastic, clear
Wandleuchte; Aluguss, schwarz / Kunststoff, klar
Applique; fonte d'aluminium, noir / plastique, transparent

L 180, H 200, A 120



9 002759 934071





93099



93408

93099 ALORIA

pedestal light; cast aluminium, black / plastic, clear
Sockelleuchte; Aluguss, schwarz / Kunststoff, klar
luminaire pour socle; fonte d'aluminium, noir / plastique, transparent

L 170, B 170, H 300, Base: Ø 170



E27



1x 60W



IP44



9 002759 930998

93408 ALORIA

floor light; cast aluminium, black / plastic, clear
Stehleuchte; Aluguss, schwarz / Kunststoff, klar
lampadaire; fonte d'aluminium, noir / plastique, transparent

L 170, B 170, H 940, Base: Ø 170



E27



1x 60W



IP44



9 002759 934088



93403

DESIGN
HIGHLIGHT
DETAIL

93095 ALORIA

wall light; cast aluminium, white / plastic, clear
Wandleuchte; Aluguss, weiss / Kunststoff, klar
Applique; fonte d'aluminium, blanc / plastique, transparent

L 170, H 225, A 190



E27



1x 60W



IP44

93403 ALORIA

wall light; cast aluminium, white / plastic, clear
Wandleuchte; Aluguss, weiss / Kunststoff, klar
Applique; fonte d'aluminium, blanc / plastique, transparent

L 180, H 200, A 120



E27



1x 60W



IP44



9 002759 930950



9 002759 934033





93095





93456



93458



110°, 7 m
5 sec. - 5 min.

**SAFETY &
COMFORT**



93457

93456 NAVEDO

wall light; cast aluminium, black, silver-patina / glass, clear
Wandleuchte; Aluguss, schwarz, silber-patina / Glas, klar
Applique; fonte d'aluminium, noir, argent patiné / verre, transparent

L 200, H 475, A 285



9 002759 934569



93457 NAVEDO

wall light; cast aluminium, black, silver-patina / glass, clear
Wandleuchte; Aluguss, schwarz, silber-patina / Glas, klar
Applique; fonte d'aluminium, noir, argent patiné / verre, transparent

L 200, H 475, A 285



9 002759 934576



93458 NAVEDO

wall light; cast aluminium, black, silver-patina / glass, clear
Wandleuchte; Aluguss, schwarz, silber-patina / Glas, klar
Applique; fonte d'aluminium, noir, argent patiné / verre, transparent

L 200, H 425, A 285



9 002759 934583





93459



93462

DESIGN
HIGHLIGHT
DETAIL



93459 NAVEDO

wall light; cast aluminium, black, silver-patina / glass, clear
Wandleuchte; Aluguss, schwarz, silber-patina / Glas, klar
Applique; fonte d'aluminium, noir, argent patiné / verre, transparent

L 290, H 430, A 130



E27



1x 60 W



IP44

93462 NAVEDO

pedestal light; cast aluminium, black, silver-patina / glass, clear
Sockelleuchte; Aluguss, schwarz, silber-patina / Glas, klar
luminaire pour socle; fonte d'aluminium, noir, argent patiné / verre, transparent

H 470, Ø 230, Base: Ø 170



E27



1x 60 W



IP44



9 002759 934590



9 002759 934620





93448



93447



110°, 7 m
5 sec. - 5 min.

**SAFETY &
COMFORT**



93448 NAVEDO

wall light; cast aluminium, white / glass, clear
Wandleuchte; Aluguss, weiss / Glas, klar
Applique; fonte d'aluminium, blanc / verre, transparent

L 290, H 430, A 130



93447 NAVEDO

wall light; cast aluminium, white / glass, clear
Wandleuchte; Aluguss, weiss / Glas, klar
Applique; fonte d'aluminium, blanc / verre, transparent

L 200, H 425, A 285



93445 NAVEDO

wall light; cast aluminium, white / glass, clear
Wandleuchte; Aluguss, weiss / Glas, klar
Applique; fonte d'aluminium, blanc / verre, transparent

L 200, H 475, A 285

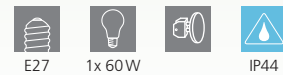



93445



93463



93452



93464

93463 NAVEDO

floor light; cast aluminium, black, silver-patina / glass, clear
Stehleuchte; Aluguss, schwarz, silber-patina / Glas, klar
lampadaire; fonte d'aluminium, noir, argent patiné / verre, transparent

H 1200, Ø 230, Base: Ø 170



E27 1x 60W IP44



9 002759 934637



93452 NAVEDO

floor light; cast aluminium, white / glass, clear
Stehleuchte; Aluguss, weiss / Glas, klar
lampadaire; fonte d'aluminium, blanc / verre, transparent

H 1200, Ø 230, Base: Ø 170

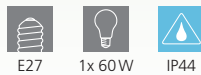

E27 1x 60W IP44



9 002759 934521



93464 NAVEDO

floor light; cast aluminium, black, silver-patina / glass, clear
Stehleuchte; Aluguss, schwarz, silber-patina / Glas, klar
lampadaire; fonte d'aluminium, noir, argent patiné / verre, transparent

H 2000, Ø 230, Base: Ø 245



E27 1x 60W IP44



9 002759 934644





93465



93454



93465 NAVEDO

floor light; cast aluminium, black, silver-patina / glass, clear
 Stehleuchte; Aluguss, schwarz, silber-patina / Glas, klar
 lampadaire; fonte d'aluminium, noir, argent patiné / verre, transparent

H 2200, Ø 560, Base: Ø 230



E27



3x 60W



IP44

Ø 560



H 2200

Ø 230



9 002759 934651

93454 NAVEDO

floor light; cast aluminium, white / glass, clear
 Stehleuchte; Aluguss, weiss / Glas, klar
 lampadaire; fonte d'aluminium, blanc / verre, transparent

H 2200, Ø 560, Base: Ø 230



E27



3x 60W



IP44

Ø 560



H 2200

Ø 230



9 002759 934545





22467



DESIGN
HIGHLIGHT
DETAIL

22467 LATERNA 4

wall light; cast aluminium, black / glass, clear
Wandleuchte; Aluguss, schwarz / Glas, klar
Applique; fonte d'aluminium, noir / verre, transparent

L 165, H 350, A 210



E27



1x 60W



IP44



9 002759 224677





22468



22469



120°, 8 m
5 sec. - 9 min.

SAFETY &
COMFORT

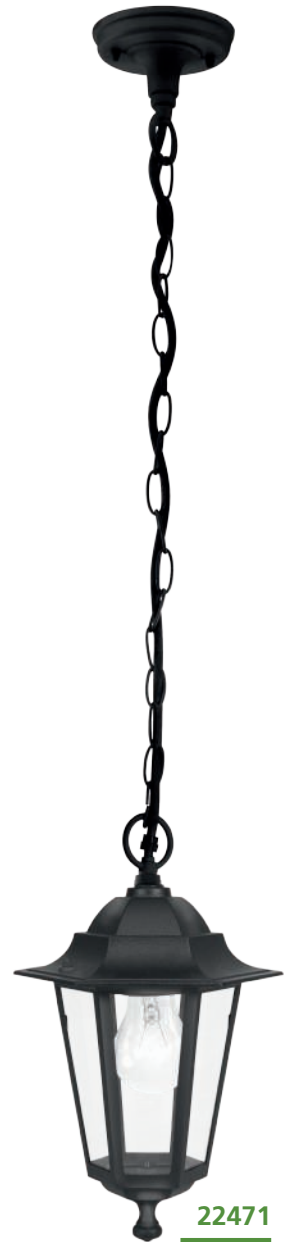

22471

22468 LATERNA 4

wall light; cast aluminium, black / glass, clear
Wandleuchte; Aluguss, schwarz / Glas, klar
Applique; fonte d'aluminium, noir / verre, transparent

L 165, H 320, A 230



E27



1x 60 W



IP44



9 002759 224684



L 165

H 320

A 230

22469 LATERNA 4

wall light; cast aluminium, black / glass, clear
Wandleuchte; Aluguss, schwarz / Glas, klar
Applique; fonte d'aluminium, noir / verre, transparent

L 165, H 360, A 215



E27



1x 60 W



IP44



9 002759 224691



L 165

H 360

A 215

22471 LATERNA 4

pendant light; cast aluminium, black / glass, clear
Hängeleuchte; Aluguss, schwarz / Glas, klar
luminaire en suspension; fonte d'aluminium, noir / verre, transparent

H 900, Ø 205



E27



1x 60 W



IP44



9 002759 224714



H 900

Ø 205



22463



22464



120°, 8 m
5 sec. - 9 min.

**SAFETY &
COMFORT**

22463 LATERNA 5

wall light; cast aluminium, white / glass, clear
Wandleuchte; Aluguss, weiss / Glas, klar
Applique; fonte d'aluminium, blanc / verre, transparent

L 165, H 320, A 230

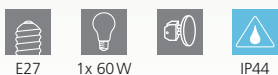

9 002759 224639



22464 LATERNA 5

wall light; cast aluminium, white / glass, clear
Wandleuchte; Aluguss, weiss / Glas, klar
Applique; fonte d'aluminium, blanc / verre, transparent

L 165, H 360, A 215



9 002759 224646



22462 LATERNA 5

wall light; cast aluminium, white / glass, clear
Wandleuchte; Aluguss, weiss / Glas, klar
Applique; fonte d'aluminium, blanc / verre, transparent

L 165, H 350, A 210



9 002759 224622





22462



22472



22144



22145

22472 LATERNA 4

pedestal light; cast aluminium, black / glass, clear
Sockelleuchte; Aluguss, schwarz / Glas, klar
luminaire pour socle; fonte d'aluminium, noir / verre, transparent

H 385, Ø 195, Base: Ø 170



E27 1x 60W IP44



9 002759 224721



22144 LATERNA 4

floor light; cast aluminium, black / glass, clear
Stehleuchte; Aluguss, schwarz / Glas, klar
lampadaire; fonte d'aluminium, noir / verre, transparent

H 1000, Ø 205, Base: Ø 170

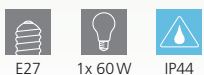

E27 1x 60W IP44



9 002759 221447

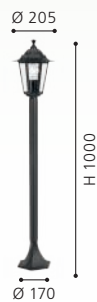

22145 LATERNA 4

floor light; cast aluminium, black / glass, clear
Stehleuchte; Aluguss, schwarz / Glas, klar
lampadaire; fonte d'aluminium, noir / verre, transparent

H 1920, Ø 550, Base: Ø 260

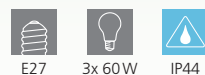

E27 3x 60W IP44



9 002759 221454





22466



22995



22996

22466 LATERNA 5

pedestal light; cast aluminium, white / glass, clear
Sockelleuchte; Aluguss, weiss / Glas, klar
luminaire pour socle; fonte d'aluminium, blanc / verre, transparent

H 385, Ø 195, Base: Ø 170



E27 1x 60W IP44



9 002759 224660

22995 LATERNA 5

floor light; cast aluminium, white / glass, clear
Stehleuchte; Aluguss, weiss / Glas, klar
lampadaire; fonte d'aluminium, blanc / verre, transparent

H 1030, Ø 195, Base: Ø 170

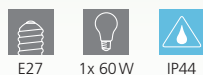

E27 1x 60W IP44



9 002759 229955

22996 LATERNA 5

floor light; cast aluminium, white / glass, clear
Stehleuchte; Aluguss, weiss / Glas, klar
lampadaire; fonte d'aluminium, blanc / verre, transparent

H 1920, Ø 535, Base: Ø 260

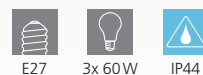

E27 3x 60W IP44



9 002759 229962

DESIGN
HIGHLIGHT
DETAIL



89767

89767 ONJA

wall light; cast aluminium, black / fluted glass, clear
Wandleuchte; Aluguss, schwarz / Glas geriffelt, klar
Applique; fonte d'aluminium, noir / verre cannelé, transparent

L 220, H 155, A 125



E27



1x 40W



IP44



9 002759 897673



89768 ONJA

wall light; cast aluminium, white / fluted glass, clear
Wandleuchte; Aluguss, weiss / Glas geriffelt, klar
Applique; fonte d'aluminium, blanc / verre cannelé, transparent

L 220, H 155, A 125



E27



1x 40W



IP44



9 002759 897680



ONJA

With direct and indirect light these luminaires create a spectacular effect.

Diese Leuchten schaffen durch direktes und indirektes Licht einen tollen Effekt.

Avec la lumière directe et indirecte, ces luminaires créent un effet spectaculaire.



89768



FUNCTIONAL

FUNKTIONELL
FONCTIONNEL



EN HIGHLIGHTS FOR OUTDOORS

Any outdoor area can be skilfully presented with spots, fitted lamps and the associated accessories. Stairwells, paths or the favourite spot in your garden will become a highlight this way.

DE HIGHLIGHTS FÜR DRAUSSEN

Mit Spots, Einbauleuchten und den dazugehörigen Accessoires lässt sich jeder Außenbereich gekonnt in Szene setzen. Treppenaufgänge, Wege oder der Lieblingssplatz im Garten werden so zum Highlight.

FR POINTS FORTS POUR L'EXTÉRIEUR

Des spots, les luminaires encastrables et les accessoires associés mettent en scène avec savoir tout espace extérieur. Les accès à des escaliers, les chemins ou bien votre emplacement préféré deviennent ainsi le centre des attentions.



OVERVIEW

FUNCTIONAL
FUNKTIONELL
FONCTIONNEL

 PAGINO 182	 NEMA 1 184	 FAEDO 4 184-185	 NEMA 185	 FAEDO 3 186-193	 DETECT ME 1 194, 197	 DETECT ME 3 194, 197	 DETECT ME 6 194, 197
 DETECT ME 5 195	 LAMEDO 198	 RIGA 3 198	 TRONTO 199	 ZIMBA-LED 201	 ZIMBA 201	 MARGO 201	 E27-LED-A60 202
 PARK 4 204-205	 CONNECTOR BOX 205	 PARK 5 206	 CUBA 208	 208			



This product is available in different colors and shapes. / Dieser Artikel ist in unterschiedlichen Farben und Formen verfügbar.
Cet article est disponible en différentes couleurs et formes.

98176

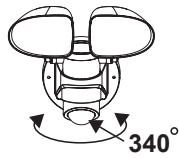

The spotlights of the luminaires are movable. The sensors of the luminaires can be swivelled 180 degrees horizontally and 135 degrees vertically. The sensor of the luminaires can be swivelled horizontally by 340 degrees.

Die Strahler der Leuchten sind beweglich. Die Sensoren der Leuchten sind um 180 Grad horizontal und 135 Grad vertikal schwenkbar. Der Sensor der Leuchten ist um 340 Grad horizontal schwenkbar.

Les spots du luminaires sont mobiles. Les capteurs du luminaires sont orientables de 180 degrés à l'horizontale et de 135 degrés à la verticale. Le capteur de la luminaire est inclinable de 340 degrés à l'horizontale, peut être orienté.

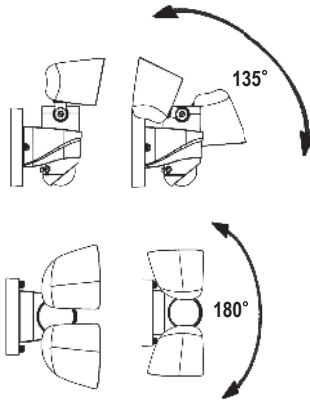

98176



150°, 12 m
5 sec. - 3 min.

SAFETY & COMFORT

98176 PAGINO

wall light; plastic, black
Wandleuchte; Kunststoff, schwarz
Applique; plastique, noir

L 245, H 220, A 180



13W



1800lm



IP44



9 002759 981761



98178 PAGINO

wall light; plastic, black
Wandleuchte; Kunststoff, schwarz
Applique; plastique, noir

L 180, H 260, A 160



13W



2200lm



IP44



9 002759 981785

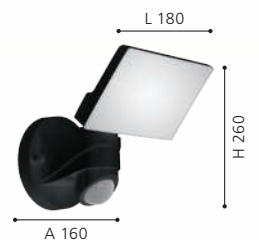



98178



150°, 12 m
5 sec. - 3 min.

**SAFETY &
COMFORT**



93384

LED



97471

LED



93385

LED

93384 NEMA 1

ground spike; plastic, black / plastic, transparent
 Erdspieß; Kunststoff, schwarz / Kunststoff, transparent
 piquet de terre; plastique, noir / plastique, transparent

93385 NEMA 1

ground spike; plastic, black / plastic, transparent
 Erdspieß; Kunststoff, schwarz / Kunststoff, transparent
 piquet de terre; plastique, noir / plastique, transparent

97471 FAEDO 4

ground spike; aluminium, black / glass, clear
 Erdspieß; Alu, schwarz / Glas, klar
 piquet de terre; aluminium, noir / verre, transparent

L 115, B 60, H 185

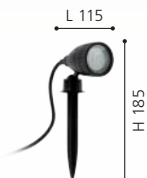
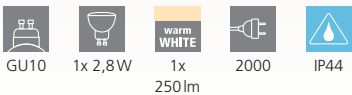

L 115, B 115, H 180

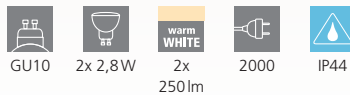

L 115, B 35, H 310

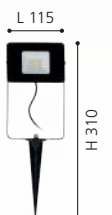



98185



94111



98185 FAEDO 4

flood light; aluminium, black / plastic, white
Strahler; Alu, schwarz / Kunststoff, weiss
projecteur; aluminium, noir / plastique, blanc

L 130, H 90, A 25



10W



900lm



1500



remote control



remote control



IP44



9 002759 981853



94111 NEMA

ground spike; stainless steel, stainless steel
Erdspieß; Edelstahl, edelstahl
piquet de terre; acier inoxydable, acier inoxydable

L 110, B 85, H 240, ET 165



GU10



1x 4,5W



1x 345lm



1500



IP54



9 002759 941116



98185

This FAEDO 4 comes with included remote control.

Diese FAEDO 4 wird mit einer Fernbedienung ausgeliefert.

Ce FAEDO 4 est livré avec une télécommande.





97455



97457



97456



97455 FAEDO 3

wall light; aluminium, black / glass, clear
Wandleuchte; Alu, schwarz / Glas, klar
Applique; aluminium, noir / verre, transparent

97456 FAEDO 3

wall light; aluminium, black / glass, clear
Wandleuchte; Alu, schwarz / Glas, klar
Applique; aluminium, noir / verre, transparent

97457 FAEDO 3

wall light; aluminium, black / glass, clear
Wandleuchte; Alu, schwarz / Glas, klar
Applique; aluminium, noir / verre, transparent

L 110, H 80, A 30



L 130, H 95, A 30



L 175, H 135, A 30



9 002759 974558

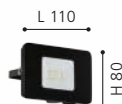

9 002759 974565



9 002759 974572

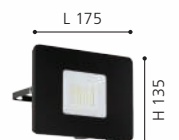



97458



900256



97458 FAEDO 3

wall light; aluminium, black / glass, clear
 Wandleuchte; Alu, schwarz / Glas, klar
 Applique; aluminium, noir / verre, transparent

L 205, H 145, A 30



900256 FAEDO 3

wall light; aluminium, black / glass, clear
 Wandleuchte; Alu, schwarz / Glas, klar
 Applique; aluminium, noir / verre, transparent

L 270, H 190, A 35





97459



120°, 12 m
5 sec. - 60 min.

**SAFETY &
COMFORT**



97462



120°, 12 m
5 sec. - 60 min.

**SAFETY &
COMFORT**



97461



120°, 12 m
5 sec. - 5 min.

**SAFETY &
COMFORT**

97459 FAEDO 3

wall light; aluminium, black / glass, clear
Wandleuchte; Alu, schwarz / Glas, klar
Applique; aluminium, noir / verre, transparent

97461 FAEDO 3

wall light; aluminium, black / glass, clear
Wandleuchte; Alu, schwarz / Glas, klar
Applique; aluminium, noir / verre, transparent

97462 FAEDO 3

wall light; aluminium, black / glass, clear
Wandleuchte; Alu, schwarz / Glas, klar
Applique; aluminium, noir / verre, transparent

L 110, H 135, A 50



10W 1000lm



IP44



9 002759 974596

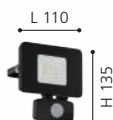

L 130, H 140, A 50



21W 2300lm



IP44



9 002759 974619



L 175, H 190, A 50



31W 3400lm



IP44



9 002759 974626





900257



120°, 1 m
5 sec. - 10 min.

**SAFETY &
COMFORT**



97463

LED



120°, 12 m
5 sec. - 60 min.

**SAFETY &
COMFORT**



900257 FAEDO 3

wall light; aluminium, black / glass, clear
Wandleuchte; Alu, schwarz / Glas, klar
Applique; aluminium, noir / verre, transparent

L 295, H 260, A 60



102W



11100lm



IP44

L 295



9 008606 234554

97463 FAEDO 3

wall light; aluminium, black / glass, clear
Wandleuchte; Alu, schwarz / Glas, klar
Applique; aluminium, noir / verre, transparent

L 205, H 200, A 50



53W



5800lm



IP44

L 205



9 002759 974633



33152



33155



33154



33152 FAEDO 3

wall light; aluminium, white / glass, clear
Wandleuchte; Alu, weiss / Glas, klar
Applique; aluminium, blanc / verre, transparent

33154 FAEDO 3

wall light; aluminium, white / glass, clear
Wandleuchte; Alu, weiss / Glas, klar
Applique; aluminium, blanc / verre, transparent

33155 FAEDO 3

wall light; aluminium, white / glass, clear
Wandleuchte; Alu, weiss / Glas, klar
Applique; aluminium, blanc / verre, transparent

L 110, H 80, A 30



L 175, B 40, H 135, A 80



L 205, H 145, A 30



9 002759 331528

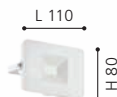

9 002759 331542

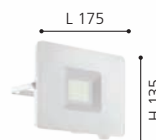

9 002759 331559





33153 FAEDO 3

wall light; aluminium, white / glass, clear

Wandleuchte; Alu, weiss / Glas, klar

Applique; aluminium, blanc / verre, transparent

L 130, H 95, A 30

LED

21W

neutral
WHITE

2300lm



IP65

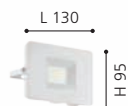



33156



120°, 12 m
5 sec. - 60 m

**SAFETY &
COMFORT**



33159



**SAFETY &
COMFORT**



33158



120°, 12 m
5 sec. - 60 min.

**SAFETY &
COMFORT**

33156 FAEDO 3

wall light; aluminium, white / glass, clear
Wandleuchte; Alu, weiss / Glas, klar
Applique; aluminium, blanc / verre, transparent

L 110, H 135, A 50



10W



1000lm



IP44



9 002759 331566

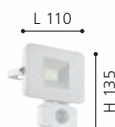

33158 FAEDO 3

wall light; aluminium, white / glass, clear
Wandleuchte; Alu, weiss / Glas, klar
Applique; aluminium, blanc / verre, transparent

L 175, H 190, A 50



31W



3400lm



IP44



9 002759 331580

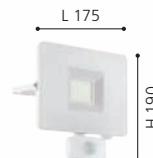

33159 FAEDO 3

wall light; aluminium, white / glass, clear
Wandleuchte; Alu, weiss / Glas, klar
Applique; aluminium, blanc / verre, transparent

L 205, H 200, A 50



53W



5800lm



IP44



9 002759 331597

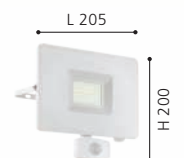



33157



120°, 12 m
5 sec. - 5 min.

SAFETY & COMFORT

33157 FAEDO 3

wall light; aluminium, white / glass, clear
Wandleuchte; Alu, weiss / Glas, klar
Applique; aluminium, blanc / verre, transparent

L 130, H 140, A 50



21 W



2300lm



IP44



9 002759 331573

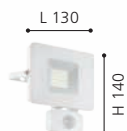



96454



180°, 12 m
10 sec. - 15 min.

**SAFETY &
COMFORT**



97465



160°, 12 m
10 sec. - 15 min.

**SAFETY &
COMFORT**



97422



360°, 12 m
10 sec. - 15 min.

**SAFETY &
COMFORT**

96454 DETECT ME 1

motion detector; plastic, black
Bewegungsmelder; Kunststoff, schwarz
détecteur de mouvement; plastique, noir

L 55, H 70, A 80



IP44



9 002759 964542



L 55

H 70

97465 DETECT ME 3

motion detector; plastic, black
Bewegungsmelder; Kunststoff, schwarz
détecteur de mouvement; plastique, noir

L 100, H 100, A 55



IP44



9 002759 974657

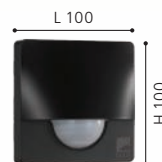

L 100

H 100

97422 DETECT ME 6

motion detector; plastic, black / plastic, white
Bewegungsmelder; Kunststoff, schwarz / Kunststoff, weiss
détecteur de mouvement; plastique, noir / plastique, blanc

Ø 90, A 55



IP44



9 002759 974220

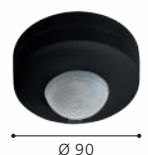

Ø 90



97419

Automatic illumination. This photo-electric lighting controller is used for controlling lighting systems for building fronts. It automatically switches light 'ON' at dusk automatically 'OFF' again at dawn. Of course, the light-level threshold at which the sensor responds and turns the light 'ON' is defined by no other than you yourself.

Automatische Beleuchtung. Der Day & Night Sensor dient zur Steuerung von Beleuchtungsanlagen an Hausfronten und schaltet bei Dämmerung automatisch das Licht AN und am Morgen automatisch wieder AUS. Die Dämmerungsschwelle, bei der der Sensor reagiert und die Beleuchtung schaltet, definieren Sie natürlich selbst.

Un éclairage automatique. Un éclairage automatique. L'interrupteur crépusculaire pour la commande des installations d'éclairage pour les façades de maison.

Il allume automatiquement la lumière au crépuscule et l'éteint automatiquement à l'aube. C'est naturellement à vous de définir le seuil de luminosité auquel doit réagir le détecteur et allumer la lumière.



97419



SAFETY & COMFORT

97419 DETECT ME 5

Sensor; plastic, black
 Sensor; Kunststoff, schwarz
 Sensor; plastique, noir

L 65, H 95, A 35



IP44

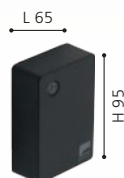



96452



180°, 12 m
10 sec. - 15 min.

**SAFETY &
COMFORT**



97464



160°, 12 m
10 sec. - 15 min.

**SAFETY &
COMFORT**



DETECT ME 1

DETECT ME 3

DETECT ME 6



MOUNT ON
CEILING



MOUNT
ON WALL

		•
•	•	

Accessories incl. / Zubehör inkl. / Accessoires inclus



10 sec. - 15 min.	10 sec. - 15 min.	10 sec. - 15 min.
12 m	12 m	12 m
180°	160°	360°
+/- 40° horizontal +/- 45° vertical		
3 - 2000 lx	3 - 2000 lx	3 - 2000 lx
max. 800 W incandescent max. 400 W fluorescent/LED	max. 1200 W incandescent max. 300 W fluorescent/LED	max. 1200 W incandescent max. 300 W fluorescent/LED



97421



360°, 12 m
10 sec. - 15 min.

**SAFETY &
COMFORT**

Ideal mounting height / Ideale Montagehöhe / Hauteur de montage ideale: ~ 2m

96452 DETECT ME 1

motion detector; plastic, white
Bewegungsmelder; Kunststoff, weiss
détecteur de mouvement; plastique, blanc

L 55, H 70, A 80



IP44



97464 DETECT ME 3

motion detector; plastic, white
Bewegungsmelder; Kunststoff, weiss
détecteur de mouvement; plastique, blanc

L 100, H 100, A 55



IP44

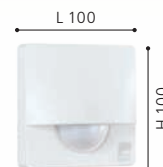

97421 DETECT ME 6

motion detector; plastic, white / plastic, white
Bewegungsmelder; Kunststoff, weiss / Kunststoff, weiss
détecteur de mouvement; plastique, blanc / plastique, blanc

Ø 90, A 55



IP44





93481



93482



86189



93481 LAMEDO

recessed ground light; stainless steel, stainless steel / satin glass, white

Bodeneinbauleuchte; Edelstahl, edelstahl / Glas satiniert, weiss
luminaire enc. au sol; acier inoxydable, acier inoxydable / verre satiné, blanc

L 100, B 100, ET 65



1x 2,5W 230lm



9 002759 934811

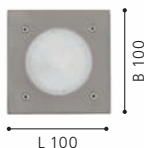

93482 LAMEDO

recessed ground light; stainless steel, stainless steel / satin glass, white

Bodeneinbauleuchte; Edelstahl, edelstahl / Glas satiniert, weiss
luminaire enc. au sol; acier inoxydable, acier inoxydable / verre satiné, blanc

Ø 100, ET 65



1x 2,5W 230lm



9 002759 934828



86189 RIGA 3

recessed ground light; stainless steel, stainless steel / plastic, white

Bodeneinbauleuchte; Edelstahl, edelstahl / Kunststoff, weiss
luminaire enc. au sol; acier inoxydable, acier inoxydable / plastique, blanc

H 285, Ø 170

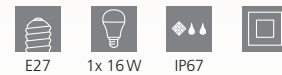

E27 1x 16W IP67



9 002759 861896



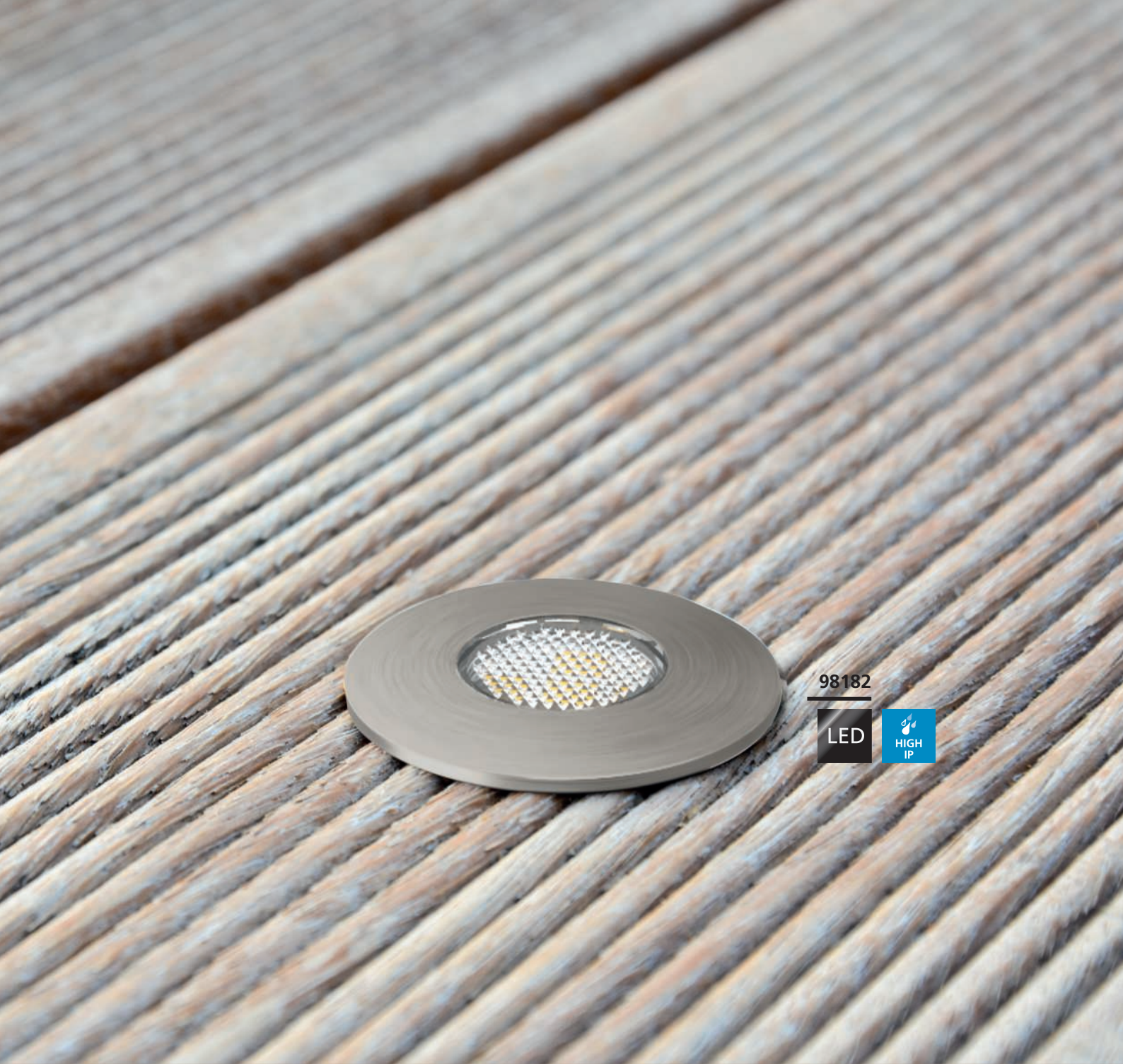

98182



98182 TRONTO

recessed ground light; stainless steel, plastic, stainless steel,
black / plastic, transparent

Bodeneinbauleuchte; Edelstahl, Kunststoff, edelstahl, schwarz /
Kunststoff, transparent

luminaire enc. au sol; acier inoxydable, plastique, acier inoxy-
dable, noir / plastique, transparent

H 2, Ø 45, ET 70



1W



50lm



Ø35



IP65/67



9 002759 981822



Ø 45



95235

LED

HIGH
IP



88575



94093



95235 ZIMBA-LED

recessed light; cast aluminium, silver
Einbauleuchte; Aluguss, silber
luminaire encastrable; fonte d'aluminium, argent

L 140, B 140, H 5, ET 95



3,7W 500lm 133x130 IP65

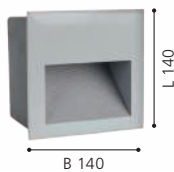

88575 ZIMBA

recessed light; cast aluminium, silver / satin glass, white
Einbauleuchte; Aluguss, silber / Glas satiniert, weiss
luminaire encastrable; fonte d'aluminium, argent / verre satiné, blanc

L 227, B 127, H 13, ET 75

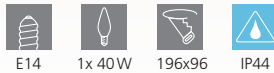

E14 1x 40W 196x96 IP44



94093 MARGO

recessed light; cast aluminium, white / satin glass, white
Einbauleuchte; Aluguss, weiss / Glas satiniert, weiss
luminaire encastrable; fonte d'aluminium, blanc / verre satiné, blanc

H 10, Ø 84, ET 125



GU10 1x 4,5W 1x 345lm Ø78 IP65/20



SAFETY &
COMFORT



DAY & NIGHT
SENSOR
INTEGRATED

110187 E27-LED-A60

806 lm	warm WHITE	3000 K	A ↑ G E
--------	---------------	--------	------------

L 106, Ø 60	not dimmable	80 CRI
7.3 W	25000 h	Day/night-Sensor
220-240V, 50/60Hz	8	
E27	7.3 W ~ 60 W	



9 008606 229086

SAFETY &
COMFORT



DAY & NIGHT
SENSOR
INTEGRATED

110189 E27-LED-A60

470 lm	warm WHITE	3000 K	A ↑ G F
--------	---------------	--------	------------

L 106, Ø 60	not dimmable	80 CRI
4.5 W	25000 h	Day/night-Sensor
220-240V, 50/60Hz	8	
E27	4.5 W ~ 40 W	



9 008606 229109

SAFETY &
COMFORT



SENSOR
DAY & NIGHT
SENSOR
INTEGRATED

110186 E27-LED-A60

830 lm	warm WHITE	2700 K	A ↑ G F
--------	---------------	--------	------------

L 116, Ø 60	not dimmable	80 CRI
9 W	25000 h	Motion Sensor & day/night-Sensor
220-240V, 50/60Hz	8	
E27	9 W ~ 60 W	



9 008606 229079



DAY & NIGHT
SENSOR
INTEGRATED

110187, 110189

These bulbs have a Day & Night sensor and switch on automatically when it gets dark or off when it gets bright. Thanks to the E27 socket the bulbs can be easily replaced in existing luminaires. With an average electricity price of € 0.16 / kWh and an average lighting duration of 8 hours / day, the costs amount to approx. € 5.00 per year.

Diese Leuchtmittel verfügen über einen Day & Night -Sensor und schalten sich selbständig bei Dunkelheit ein bzw. bei Helligkeit aus. Dank der E27 -Fassung können die Leuchtmittel einfach in bestehende Leuchten getauscht werden. Bei einem durchschnittlichen Strompreis von € 0,16 / kWh und einer durchschnittlichen Leuchtdauer von 8 Stunden / Tag belaufen sich die Kosten auf ca. € 5,00 pro Jahr.

Ces ampoules sont équipées d'un capteur Day & Night et s'allument automatiquement dans l'obscurité et s'éteignent automatiquement lorsqu'il fait clair. Grâce à la douille E27 les ampoules peuvent être facilement remplacées dans les luminaires existants. Avec un prix moyen de l'électricité de € 0,16 / kWh et une durée moyenne de d'une durée d'éclairage de 8 heures / jour, les coûts s'élèvent à environ € 5,00 par an.



110186



MICROWAVE MOTION SENSOR

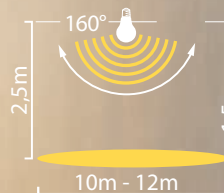



90748



93426

90748 PARK 4

accessory; stainless steel, stainless steel / plastic, green
Zubehör; Edelstahl, edelstahl / Kunststoff, grün
Accessoires; acier inoxydable, acier inoxydable / plastique, marron granit

L 110, B 110, H 400, Base: B 155, T 155



IP44



9 002759 907488

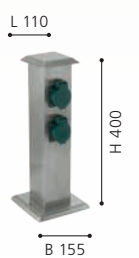



91206



CONNECTOR BOX

No more annoying cables in your garden: bury them simply and safely with the CONNECTOR BOX.

- 91206: 1 supply line and 2 distribution lines
- 91207: 1 supply line and 5 distribution lines

Mit der CONNECTOR BOX können Sie störende Kabel einfach und sicher unter der Erde verschwinden lassen.

- 91206: 1 Zuleitung und 2 Verteilungsleitungen
- 91207: 1 Zuleitung und 5 Verteilungsleitungen

Tous les câbles incommodants disparaissent simplement et sûrement dans votre jardin avec CONNECTOR BOX.

- 91206: 1 alimentation et 2 lignes de distribution
- 91207: 1 alimentation et 5 lignes de distribution



91207



93426 PARK 4

accessory; steel, plastic, black
Zubehör; Stahl, Kunststoff, schwarz
Accessoires; acier, plastique, noir

L 110, B 110, H 400, Base: B 155, T 155



IP44



9 002759 934262

91206 CONNECTOR BOX

accessory; plastic, black
Zubehör; Kunststoff, schwarz
Accessoires; plastique, noir

H 50, Ø 155



IP68



9 002759 912062



91207 CONNECTOR BOX

accessory; plastic, black
Zubehör; Kunststoff, schwarz
Accessoires; plastique, noir

H 50, Ø 155



IP68



9 002759 912079



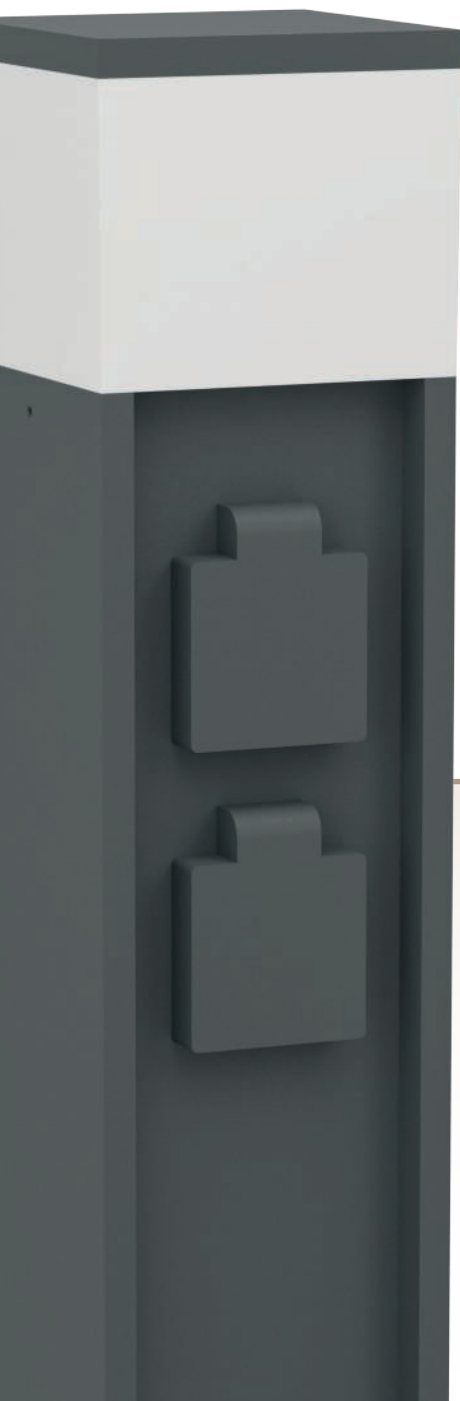

DESIGN
HIGHLIGHT
DETAIL



901031



901031 PARK 5

accessory; aluminium, anthracite
Zubehör; Alu, anthrazit
Accessoires; aluminium, gris anthracite

L 100, B 100, H 300



IP54



9 008606 297818

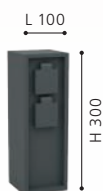

901032 PARK 5

accessory; aluminium, anthracite / plastic, white
Zubehör; Alu, anthrazit / Kunststoff, weiss
Accessoires; aluminium, gris anthracite / plastique, blanc

L 100, B 100, H 500



E27



1x 25 W



IP54



9 008606 297825

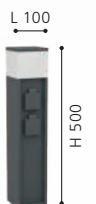



901032





88744



88153

88744

With the CUBA ground spike you can stick your floor luminaire in the ground or set it in concrete.

Mit dem CUBA Erdspeer können Sie Ihre Stehleuchte in den Boden stecken oder einbetonieren.

Avec le piquet de terre CUBA vous pouvez fixer votre lampadaire en sol ou au béton.

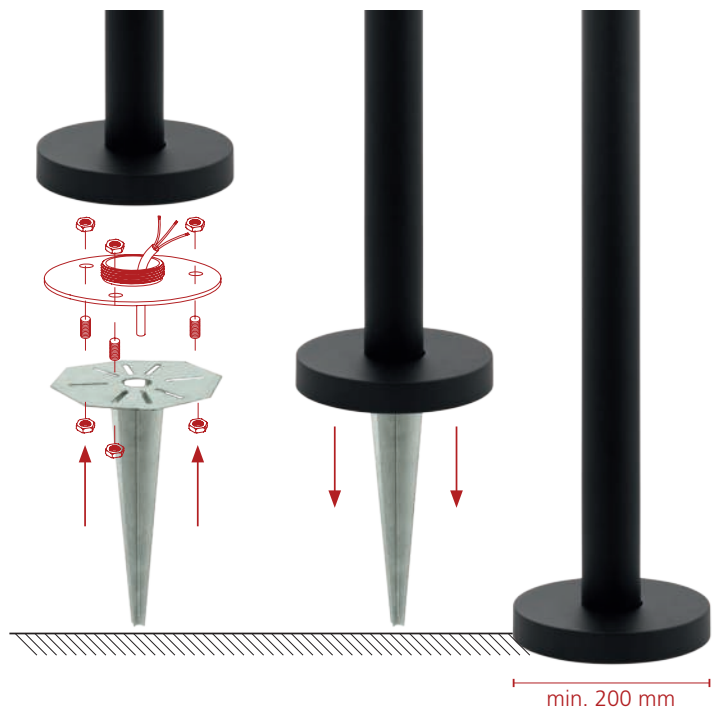

88744 CUBA

ground spike; steel, zinc-plated
Erdspeer; Stahl, feuerverzinkt
piquet de terre; acier, galvanisé à chaud

H 300, Ø 200



88153

accessory; steel, black
Zubehör; Stahl, schwarz
Accessoires; acier, noir

H 50, Ø 112

88152

accessory; steel, white
Zubehör; Stahl, weiss
Accessoires; acier, blanc

H 50, Ø 112



9 002759 887445



9 002759 881535

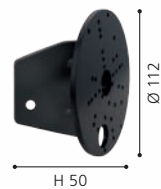

9 002759 881528

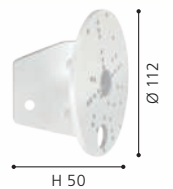



88152, 88153

The above mentioned pictogram indicates suitable luminaires which can be easily mounted on corners with this accessories.

Das oben gezeigte Piktogramm markiert passende Leuchten, welche mit dem Zubehör einfach an Ecken montiert werden können.

Le pictogramme ci-dessus marque les luminaires correspondant, qui peut être monté avec les accessoires simples dans les coins.

88152



GARDEN LIVING

GARTEN LEBEN
VIE AU JARDIN



EN OUTDOOR ATMOSPHERE

If the outdoor living room is to become an oasis of well-being, the right lighting must not be missing. The products from the Garden Living range create the right atmosphere. Cozy table and floor lamps, decorative pendant lights and light chains as well as colourful light bands transform every garden into a unique eye-catcher that invites you to linger and relax in the open air on warm summer evenings.

DE ATMOSPHERE IM FREIEN

Wenn das Outdoor-Wohnzimmer zur Wohlfühloase werden soll, darf die richtige Beleuchtung nicht fehlen. Die Produkte aus dem Garden Living Sortiment schaffen dafür die richtige Atmosphäre. Wohnliche Tisch- und Stehleuchten, dekorative Hängeleuchten und Lichterketten sowie farbenfrohe Leuchtbänder verwandeln jeden Garten in einen einzigartigen Blickfang, der zum Verweilen und Relaxen an warmen Sommerabenden unter freiem Himmel einlädt.

FR AMBIANCE EXTÉRIEURE

Pour que le salon extérieur devienne une oasis de bien-être, le bon éclairage ne doit pas manquer. Les produits de la gamme Garden Living créent l'atmosphère adéquate. Des lampes de table et des lampadaires confortables, des suspensions et des chaînes lumineuses décoratives, ainsi que des bandes lumineuses colorées transforment chaque jardin en une attraction unique qui vous invite à vous attarder et à vous détendre en plein air lors des chaudes soirées d'été.



OVERVIEW

GARDEN LIVING
GARTEN LEBEN
VIE AU JARDIN

 PICCOLA 213	 PONENTE 214	 SINGLE CHARGING PAD 215	 MULTI CHARGING PAD 215	 MEGGIANO 217	 MANNERA 218-219	 LADUNARA 220	 FOSSOMBRONE 220
 FUSIGNANO 220	 ALGHERA 222	 BOTTONA 222	 MONTEROLO 224-225	 MONTEROLLO SMOKE 226	 VIGNANELLO 227	 PARTAJ 228	 CUBONE 228
 FROSOLONE 230	 LIBISA 230	 SPINETOLI 2 231	 FLATNEONLED 232-233				



This product is available in different colors and shapes. / Dieser Artikel ist in unterschiedlichen Farben und Formen verfügbar.
Cet article est disponible en différentes couleurs et formes.



900924

LED

HIGH IP



900923



900925



PICCOLA

The luminaires are supplied with a USB-C cable and can be charged with the cable or the charging stations 901093 and 901094 can be charged.

Leuchten werden mit USB-C Kabel geliefert und können mit dem Kabel oder den Ladestationen 901093 und 901094 geladen werden.

Les luminaires sont livrés avec un câble USB-C et peuvent être rechargées avec le câble ou les stations de recharge 901093 et 901094 peuvent être chargées.

900924 PICCOLA

table light; steel, dark bronze / plastic, white
Tischleuchte; Stahl, bronze dunkel / Kunststoff, weiss
luminaire de table; acier, bronze foncé / plastique, blanc

H 280, Ø 130, Base: Ø 70



900923 PICCOLA

table light; steel, brushed brass / plastic, white
Tischleuchte; Stahl, messing-gebürstet / Kunststoff, weiss
luminaire de table; acier, laiton brossé / plastique, blanc

H 280, Ø 130, Base: Ø 70



900925 PICCOLA

table light; steel, black / plastic, white
Tischleuchte; Stahl, schwarz / Kunststoff, weiss
luminaire de table; acier, noir / plastique, blanc

H 280, Ø 130, Base: Ø 70





900982



900983



900984



PONENTE

The luminaires are supplied with a USB-C cable and can be charged with the cable or the charging stations 901093 and 901094 can be charged.

Leuchten werden mit USB-C Kabel geliefert und können mit dem Kabel oder den Ladestationen 901093 und 901094 geladen werden.

Les luminaires sont livrés avec un câble USB-C et peuvent être rechargées avec le câble ou les stations de recharge 901093 et 901094 peuvent être chargées.

900982 PONENTE

table light; steel, white / plastic, white
Tischleuchte; Stahl, weiss / Kunststoff, weiss
luminaire de table; acier, blanc / plastique, blanc

H 200, Ø 160, Base: Ø 65



900983 PONENTE

table light; steel, black / plastic, black-transparent
Tischleuchte; Stahl, schwarz / Kunststoff, schwarz-transparent
luminaire de table; acier, noir / plastique, noir transparent

H 200, Ø 160, Base: Ø 65



900984 PONENTE

table light; steel, black / glass, white
Tischleuchte; Stahl, schwarz / Glas, weiss
luminaire de table; acier, noir / verre, blanc

H 200, Ø 160, Base: Ø 65



901093

Wireless charging simplifies cable management.
Kabelloses Aufladen vereinfacht das Kabelmanagement.
La recharge sans fil simplifie la gestion des câbles.



901094

Wireless charging of up to 6 luminaires. Several Multi Charging Pads can be plugged together to charge even more luminaires at the same time.

Kabelloses Aufladen von bis zu 6 Leuchten. Mehrere Multi Charging Pads können aneinander gesteckt werden, um noch mehr Leuchten gleichzeitig zu laden.

Chargement sans fil jusqu'à 6 lumières. Plusieurs Multi Charging Pads peuvent être branchés les uns aux autres pour charger encore plus de luminaires en même temps.



901093



901094

901093 SINGLE CHARGING PAD

accessory; plastic, black
Zubehör; Kunststoff, schwarz
Accessoires; plastique, noir

H 17, Ø 77



901094 MULTI CHARGING PAD

accessory; black
Zubehör; schwarz
Accessoires; noir

L 518, B 320, H 35



9 008606 297832



9 008606 297849

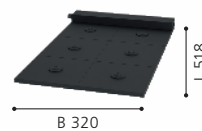



900978



900978





MEGGIANO

Multifunctional battery table luminaires: The head is magnetic and removable, on the bottom of the head there is a bracket for hanging. Thus, the luminaires can be used as table luminaires with base, as pendants luminaires and as floor luminaires.

Multifunktionale Akkutischleuchten: Der Kopf ist magnetisch und abnehmbar, auf der Kopfunterseite befindet sich ein Bügel zum Aufhängen. Somit können die Leuchten als Tischleuchten mit Fuß, als Hängeleuchten und als Bodenleuchten verwendet werden.

Luminaires de table à piles multifonctionnelles : La tête est magnétique et amovible, sur la partie inférieure de la tête se trouve un étrier pour la suspendre. Ainsi, les luminaires peuvent être utilisées comme luminaires de table avec pied, comme luminaires suspendues et comme luminaires de sol.



900979



900981



900978 MEGGIANO

table light; plastic, grey / plastic, white
Tischleuchte; Kunststoff, grau / Kunststoff, weiss
luminaire de table; plastique, gris / plastique, blanc

H 320, Ø 150, Base: Ø 125



900979 MEGGIANO

table light; plastic, purple / plastic, white
Tischleuchte; Kunststoff, lila / Kunststoff, weiss
luminaire de table; plastique, violet / plastique, blanc

H 320, Ø 150, Base: Ø 125



900981 MEGGIANO

table light; plastic, green / plastic, white
Tischleuchte; Kunststoff, grün / Kunststoff, weiss
luminaire de table; plastique, vert / plastique, blanc

H 320, Ø 150, Base: Ø 125





900457



900457 MANNERA

table light; aluminium, steel, black / plastic, white
Tischleuchte; Alu, Stahl, schwarz / Kunststoff, weiss
luminaire de table; aluminium, acier, noir / plastique, blanc

H 340, Ø 110, Base: Ø 110



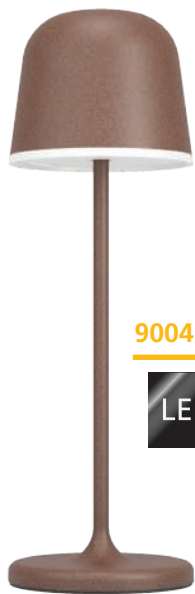

900459

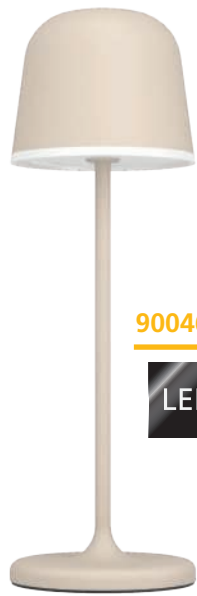

900461

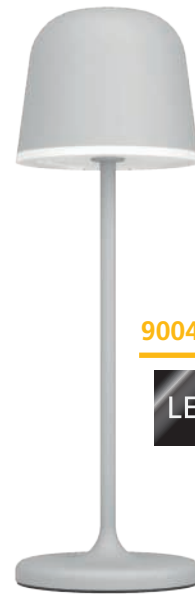

900458



900459 MANNERA

table light; aluminium, steel, auburn / plastic, white
Tischleuchte; Alu, Stahl, rostbraun / Kunststoff, weiss
luminaire de table; aluminium, acier, brun rouille / plastique, blanc

H 340, Ø 110, Base: Ø 110



900461 MANNERA

table light; aluminium, steel, sandy / plastic, white
Tischleuchte; Alu, Stahl, sandfarben / Kunststoff, weiss
luminaire de table; aluminium, acier, couleur sable / plastique, blanc

H 340, Ø 110, Base: Ø 110



900458 MANNERA

table light; aluminium, steel, grey / plastic, white
Tischleuchte; Alu, Stahl, grau / Kunststoff, weiss
luminaire de table; aluminium, acier, gris / plastique, blanc

H 340, Ø 110, Base: Ø 110





900259



900122



900259 LADUNARA

floor light; steel, black
Stehleuchte; Stahl, schwarz
lampadaire; acier, noir

H 1170, Ø 250, Base: Ø 660

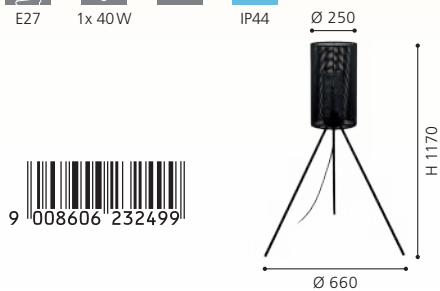

900122 FOSSOMBRONE

floor light; zinc-plated steel, black / plastic, white
Stehleuchte; Stahl verzinkt, schwarz / Kunststoff, weiss
lampadaire; acier galvanisé, noir / plastique, blanc

H 685, Ø 320, Base: Ø 230

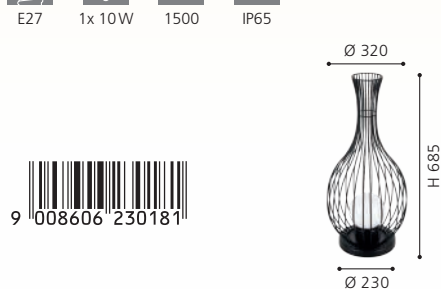
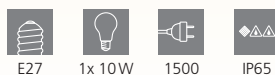

900123 FUSIGNANO

table light; zinc-plated steel, black / etched glass, white
Tischleuchte; Stahl verzinkt, schwarz / Glas geätzt, weiss
luminaire de table; acier galvanisé, noir / verre gravé, blanc

H 410, Ø 265

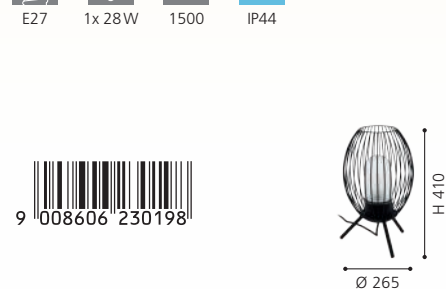
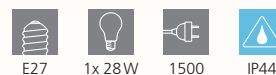



900123



900296

On/off switch on the lampshade.

Ein/Aus-Schalter am Lampenschirm.

Interrupteur marche/arrêt sur l'abat-jour.

900296



900296 ALGHERA

floor light; plastic, black / plastic, white
 Stehleuchte; Kunststoff, schwarz / Kunststoff, weiss
 lampadaire; plastique, noir / plastique, blanc

H 1485, Ø 390



E27 1x 15W 2000 IP44



9 008606 232598

900295 BOTTONA

floor light; plastic, white
 Stehleuchte; Kunststoff, weiss
 lampadaire; plastique, blanc

L 400, B 400, H 400



E27 1x 15W 2000 IP65

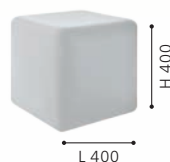

9 008606 232581

900294 BOTTONA

floor light; plastic, white
 Stehleuchte; Kunststoff, weiss
 lampadaire; plastique, blanc

L 300, B 300, H 300



E27 1x 15W 2000 IP65

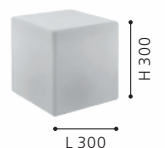

9 008606 232574



900295



900294





98101



98103



98101 MONTEROLO

floor light; plastic, white / plastic, white
Stehleuchte; Kunststoff, weiss / Kunststoff, weiss
lampadaire; plastique, blanc / plastique, blanc

H 300, Ø 300, Base: Ø 120



98103 MONTEROLO

floor light; plastic, white / plastic, white
Stehleuchte; Kunststoff, weiss / Kunststoff, weiss
lampadaire; plastique, blanc / plastique, blanc

H 500, Ø 500, Base: Ø 195

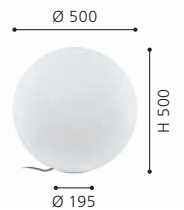



98104



98102



98104 MONTEROLO

floor light; plastic, white / plastic, white
 Stehleuchte; Kunststoff, weiss / Kunststoff, weiss
 lampadaire; plastique, blanc / plastique, blanc

H 600, Ø 600, Base: Ø 195

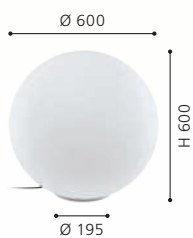

98102 MONTEROLO

floor light; plastic, white / plastic, white
 Stehleuchte; Kunststoff, weiss / Kunststoff, weiss
 lampadaire; plastique, blanc / plastique, blanc

H 390, Ø 390, Base: Ø 195

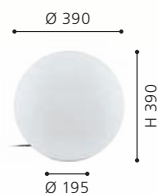



900203

900202

900201

900201 MONTEROLLO SMOKE

ground spike; plastic, black / plastic, black-transparent
 Erdspieß; Kunststoff, schwarz / Kunststoff, schwarz-transparent
 piquet de terre; plastique, noir / plastique, noir transparent

H 240, Ø 200



E27 1x 40W 5000 IP44



9 008606 229895



900202 MONTEROLLO SMOKE

ground spike; plastic, black / plastic, black-transparent
 Erdspieß; Kunststoff, schwarz / Kunststoff, schwarz-transparent
 piquet de terre; plastique, noir / plastique, noir transparent

H 340, Ø 300



E27 1x 40W 5000 IP44



9 008606 229901



900203 MONTEROLLO SMOKE

ground spike; plastic, black / plastic, black-transparent
 Erdspieß; Kunststoff, schwarz / Kunststoff, schwarz-transparent
 piquet de terre; plastique, noir / plastique, noir transparent

H 440, Ø 400

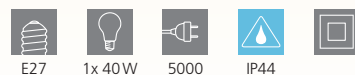

E27 1x 40W 5000 IP44



9 008606 229918





900209



900211



900208



VIGNANELLO

4x AA batteries needed (Batteries not included).

4x AA Batterien erforderlich (Batterien sind nicht inkludiert).

4x AA batteries nécessaires (Les piles sont non inclus).

900209 VIGNANELLO

hanging decoration; plastic, black / plastic, black-transparent
Dekoration zum Aufhängen; Kunststoff, schwarz / Kunststoff, schwarz-transparent

Déco de Noël à suspendre; plastique, noir / plastique, noir transparent

H 195, Ø 125



1x 0,06W



WARM WHITE



IP44



IP44



9 008606 229932



900211 VIGNANELLO

hanging decoration; plastic, black / plastic, amber
Dekoration zum Aufhängen; Kunststoff, schwarz / Kunststoff, amber

Déco de Noël à suspendre; plastique, noir / plastique, ambre

H 195, Ø 125



1x 0,06W



WARM WHITE



IP44



IP44



9 008606 229949



900208 VIGNANELLO

hanging decoration; plastic, black / plastic, transparent
Dekoration zum Aufhängen; Kunststoff, schwarz / Kunststoff, transparent

Déco de Noël à suspendre; plastique, noir / plastique, transparent

H 195, Ø 125



1x 0,06W



WARM WHITE



IP44



IP44



9 008606 229925





900238

LED

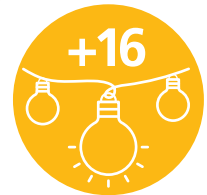

900213

LED



900238 PARTAJ

fairy lights; plastic, white / plastic, transparent
 Lichterkette; Kunststoff, weiss / Kunststoff, transparent
 Guirlande lumineuse; plastique, blanc / plastique, transparent

900213 PARTAJ

fairy lights; plastic, black / plastic, transparent
 Lichterkette; Kunststoff, schwarz / Kunststoff, transparent
 Guirlande lumineuse; plastique, noir / plastique, transparent

900215 CUBONE

fairy lights; plastic, grey, black / plastic, transparent
 Lichterkette; Kunststoff, grau, schwarz / Kunststoff, transparent
 Guirlande lumineuse; plastique, gris, noir / plastique, transparent

L 4500, B 60, H 95

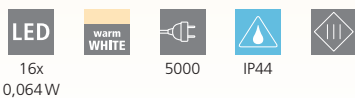

L 4500, B 60, H 95



L 4950, B 90, H 105

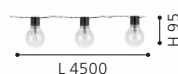
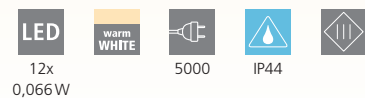



900215

LED





900212

LED



900239

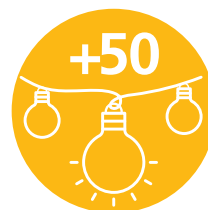

LED



900299

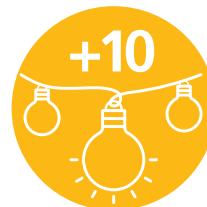

LED

900117, 900299

Timer function: 8h on and 16h off when timer is activated.

Timerfunktion: 8h an und 16h aus bei Timer Aktivierung.

Fonction minuterie : 8h de marche et 16h d'arrêt lorsque la minuterie est activée.

900299

2x AA batteries needed. Batteries not included.

2x AA Batterien erforderlich. Batterien sind nicht inkludiert.

2x AA batteries nécessaires. Les piles sont non inclus.

900212 FROSLONE

fairy lights; plastic, green / plastic, coloured
Lichterkette; Kunststoff, grün / Kunststoff, bunt
Guirlande lumineuse; plastique, vert / plastique, coloré

L 5700, B 50, H 110



20x
0,064W



5000



IP44



900239 LIBISA

fairy lights; plastic, white
Lichterkette; Kunststoff, weiss
Guirlande lumineuse; plastique, blanc

L 7350, B 25, H 35



50x
0,066W



3000



IP44



900299 LIBISA

fairy lights; plastic, black-transparent
Lichterkette; Kunststoff, schwarz-transparent
Guirlande lumineuse; plastique, noir transparent

L 4050, B 57, H 110



10x
0,06W



3000



IP44



9 008606 229741



L 5700



9 008606 229987



L 7350



9 008606 230068



L 4050

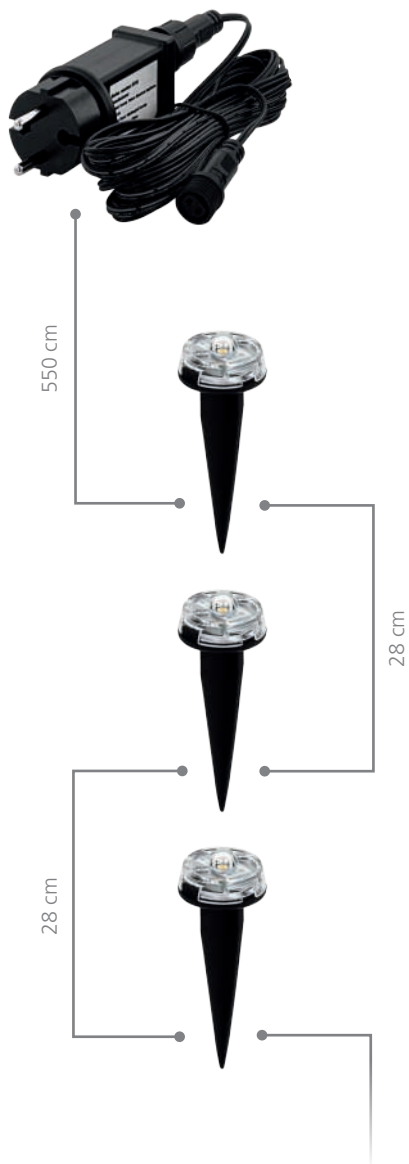

900117 SPINETOLI 2

ground spike; plastic, transparent / plastic, transparent
 Erdspieß; Kunststoff, transparent / Kunststoff, transparent
 piquet de terre; plastique, transparent / plastique, transparent

L 6900, B 30, H 10, ET 500



900117

LED





900219

LED



900221

LED



900224

LED



900223

LED

900219 FLATNEONLED

bar/strip light; plastic, pink
Leuchtband/-stab; Kunststoff, pink
bande lumineuse / bâton l; plastique, rose

L 5000, B 15, H 6

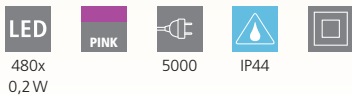

480x
0,2W



9 008606 229802



L 5000

900221 FLATNEONLED

bar/strip light; plastic, blue
Leuchtband/-stab; Kunststoff, blau
bande lumineuse / bâton l; plastique, bleu

L 5000, B 15, H 6



480x
0,2W



9 008606 229819



L 5000

900223 FLATNEONLED

bar/strip light; plastic, red
Leuchtband/-stab; Kunststoff, rot
bande lumineuse / bâton l; plastique, rouge

L 5000, B 15, H 6

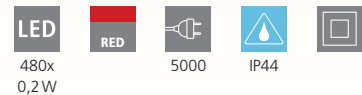

480x
0,2W



9 008606 229833



L 5000

DESIGN
HIGHLIGHT
DETAIL



900222

LED

900224 FLATNEONLED

bar/strip light; plastic, coloured
Leuchtband/-stab; Kunststoff, bunt
bande lumineuse / bâton l; plastique, coloré

L 3000, B 15, H 16



288x
0,2W



5000



IP44



9 008606 229864

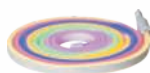

L 3000

900222 FLATNEONLED

bar/strip light; plastic, green
Leuchtband/-stab; Kunststoff, grün
bande lumineuse / bâton l; plastique, marron granit

L 5000, B 15, H 6



480x
0,2W



5000



IP44



9 008606 229826



L 5000



SOLAR

SOLAR
SOLAIRE



EN THE GREEN ALTERNATIVE

These exterior lights all feature modern solar technology and high-quality batteries. With zero electricity costs, they make the perfect statement for anyone who values sustainability. Since they don't need cables or a power connection, these lights can be placed anywhere where there is enough sunlight.

DE DIE GRÜNE ALTERNATIVE

Diese Außenleuchten verfügen alle über moderne Solartechnologie und hochwertige Akkus. Sie sind das perfekte Statement für alle jene, denen Nachhaltigkeit wichtig ist und verursachen keine Stromkosten. Unabhängig von Kabel- und Stromanschluss sind diese Leuchten überall platzierbar wo genügend Sonne scheint.

FR LA SOLUTION ÉCOLOGIQUE

Ces luminaires extérieurs sont tous équipés d'une technologie solaire moderne et de batteries performantes. Ils représentent le choix idéal pour tous ceux qui accordent une grande importance à la protection de l'environnement. Par ailleurs, ils n'engendrent pas de frais énergétiques. Ces luminaires n'ont pas besoin d'être raccordés à l'alimentation et peuvent donc être placés partout où ils peuvent être exposés au soleil.



OVERVIEW

SOLAR
SOLAR
SOLAIRE



DREOLI
238



CERRISI
238



CORBEZZOLA
240



MARTANO
240



USIGNI
241



MARLIANO
241



ALTILIA
242



PANTETE
245



SPIANTE
246



BARACCONI
246



UTRERA
248



CROARA
248



PASTION
248



STIAPPA
249



SUZZARA
249



LAMOZZO
250



PORRASSA
250



SAMBUCO
251



PANETTIERI
252



VILLAGRAPPA
252



CASABAS
253



PALIZZI
252



This product is available in different colors and shapes. / Dieser Artikel ist in unterschiedlichen Farben und Formen verfügbar.
Cet article est disponible en différentes couleurs et formes.

OPERATING MODES

BETRIEBSMODI

MODES DE FONCTIONNEMENT

Our solar lights with motion sensor offer an efficient lighting solution for outdoor areas. Most of the lights can be operated in different modes.

In motion mode, the product lights up at full brightness for some time when motion is detected.

In twilight mode, the product is automatically activated at dusk and switched off in daylight. To extend the battery life, the light is operated at reduced brightness in this mode.

An overview of which lights can be operated in which mode can be found on the right-hand side.

Unsere Solarleuchten mit Bewegungssensor bieten eine effiziente Beleuchtungslösung für den Außenbereich. Die meisten Leuchten können dabei in verschiedenen Modi betrieben werden.

Im Bewegungsmodus leuchtet das Produkt bei erkannter Bewegung für einige Zeit bei voller Helligkeit auf.

Im Dämmerungsmodus erfolgt die automatische Aktivierung bei Einbruch der Dunkelheit und Abschaltung bei Tageslicht. Um die Batterielebensdauer zu verlängern, wird bei diesem Modus die Leuchte bei reduzierter Helligkeit betrieben.

Eine Übersicht, welche Leuchten in welchem Modus betrieben werden können, finden Sie auf der rechten Seite.

Nos lampes solaires à détecteur de mouvement offrent une solution d'éclairage efficace pour l'extérieur. La plupart des lampes peuvent être utilisées dans différents modes.

En mode mouvement, le produit s'allume à pleine luminosité pendant un certain temps lorsqu'un mouvement est détecté.

En mode crépusculaire, il s'active automatiquement à la tombée de la nuit et s'éteint à la lumière du jour. Pour prolonger la durée de vie des piles, ce mode permet de faire fonctionner le luminaire à une luminosité réduite.

Vous trouverez sur la droite un aperçu des luminaires qui peuvent être utilisés dans tel ou tel mode.



100% brightness
100% Helligkeit/ 100% Luminosité



SERIES NAME Seriename Nom de la série de lampes	 MOTIONSENSOR Bewegungsmodus Capteur de mouvement	 DAY & NIGHT SENSOR Dämmerungsmodus Mode crépusculaire
DREOLI	●	●
CERRISI	●	●
CORBEZZOLA	●	
MARTANO	●	
USIGNI		
MARLIANO		
ALTILIA	●	●
PANTETE	●	●
BARACCONI	●	
SPIANTE	●	●
UTRERA	●	●
PASTION	●	●
CROARA	●	
STIAPPA	●	●
SUZZARA	●	●
LAMOZZO	●	●
PORRASSA	●	
SAMBUCO		
PALIZZI	●	●
VILLAGRAPPA	●	●
PANETTIERI	●	●
CASABAS	●	



901071



120°, 6 m

SAFETY & COMFORT

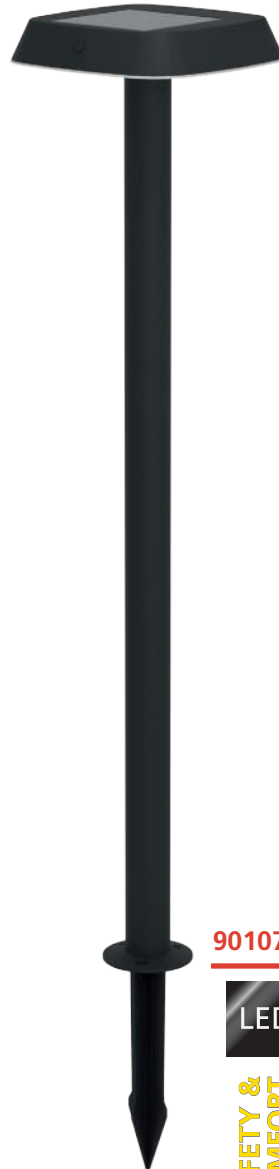

901072



120°, 3 m

SAFETY & COMFORT



901071 DREOLI

solar light; plastic, black / plastic, white
Solarleuchte; Kunststoff, schwarz / Kunststoff, weiss
luminaire solaire; plastique, noir / plastique, blanc

L 175, H 210, A 175

LED 8,5W warm WHITE 970lm ACCU Li-ion 2200mAh

IP44



901072 DREOLI

solar light; plastic, black / plastic, white
Solarleuchte; Kunststoff, schwarz / Kunststoff, weiss
luminaire solaire; plastique, noir / plastique, blanc

L 175, B 175, H 1035

LED 8,5W warm WHITE 1030lm ACCU Li-ion 2200mAh

IP44



901079 CERRISI

solar light; plastic, black / plastic, white
Solarleuchte; Kunststoff, schwarz / Kunststoff, weiss
luminaire solaire; plastique, noir / plastique, blanc

L 250, H 105, A 300

LED 7W warm WHITE 800lm ACCU Li-ion 2200mAh

IP44





901079

LED



120°, 6 m

SAFETY &
COMFORT

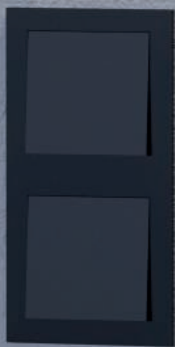



900804



110°, 8 m
45 sec. - 45 sec.

SAFETY &
COMFORT



900243



120°, 8 m

SAFETY &
COMFORT



900805



90°, 8 m
45 sec. - 45 sec.

SAFETY &
COMFORT

900243 CORBEZZOLA

wall light; plastic, graphite / plastic, white
Wandleuchte; Kunststoff, graphit / Kunststoff, weiss
Applique; plastique, noir graphite / plastique, blanc

L 160, H 160, A 200



900804 MARTANO

wall light; aluminium, black / plastic, white
Wandleuchte; Alu, schwarz / Kunststoff, weiss
Applique; aluminium, noir / plastique, blanc

L 180, B 150, H 270



900805 MARTANO

pedestal light; aluminium, black / plastic, white
Sockelleuchte; Alu, schwarz / Kunststoff, weiss
luminaire pour socle; aluminium, noir / plastique, blanc

L 150, B 150, H 800

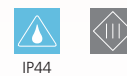

901087, 901088, 901089

These luminaires can also be loaded with the supplied USB-C cable.

Diese Leuchten sind zusätzlich mit dem mitgelieferten USB-C Kabel ladbar.

Ces luminaires peuvent également être chargés du câble USB-C fourni.



901087

LED



901089

LED



901088

LED

901089 USIGNI

solar light; plastic, black / plastic, white
Solarleuchte; Kunststoff, schwarz / Kunststoff, weiss
luminaire solaire; plastique, noir / plastique, blanc

L 150, B 150, H 280

LED

2,5W

neutral
WHITE

300lm



ACCU

Li-ion

1800mAh



IP44



901087 MARLIANO

solar light; wood, steel, brown / plastic, white
Solarleuchte; Holz, Stahl, braun / Kunststoff, weiss
luminaire solaire; bois, acier, marron / plastique, blanc

H 240, Ø 210

LED

2,5W

neutral
WHITE

300lm



ACCU

Li-ion

1800mAh



IP44

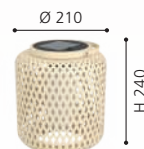

901088 MARLIANO

solar light; wood, steel, brown, black / plastic, white
Solarleuchte; Holz, Stahl, braun, schwarz / Kunststoff, weiss
luminaire solaire; bois, acier, marron, noir / plastique, blanc

H 240, Ø 210

LED

2,5W

neutral
WHITE

300lm



ACCU

Li-ion

1800mAh



IP44

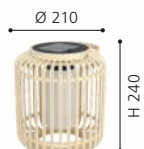



901073



120°, 6 m

**SAFETY &
COMFORT**



901075



120°, 3 m

**SAFETY &
COMFORT**



901073 ALTILIA

solar light; plastic, black / plastic, white
Solarleuchte; Kunststoff, schwarz / Kunststoff, weiss
luminaire solaire; plastique, noir / plastique, blanc

L 155, H 200, A 230



901075 ALTILIA

solar light; plastic, black / plastic, white
Solarleuchte; Kunststoff, schwarz / Kunststoff, weiss
luminaire solaire; plastique, noir / plastique, blanc

L 155, B 155, H 1060



901074 ALTILIA

solar light; plastic, black / plastic, white
Solarleuchte; Kunststoff, schwarz / Kunststoff, weiss
luminaire solaire; plastique, noir / plastique, blanc

L 155, B 155, H 560





901074

LED



120°, 3 m

SAFETY &
COMFORT



901076



120° 6 m

SAFETY &
COMFORT





901077

LED



120°, 3 m

SAFETY & COMFORT

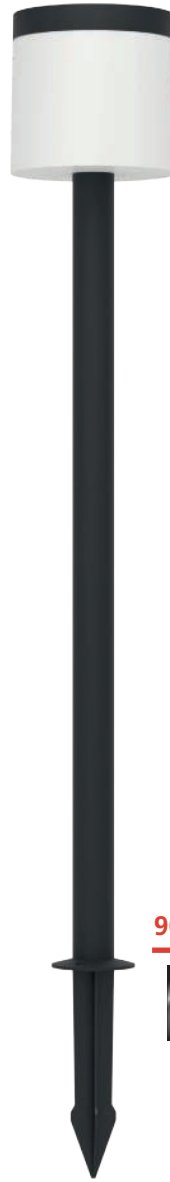

901078

LED



120°, 3 m

SAFETY & COMFORT

901076 PANTETE

solar light; plastic, black / plastic, white
Solarleuchte; Kunststoff, schwarz / Kunststoff, weiss
luminaire solaire; plastique, noir / plastique, blanc

H 210, Ø 175, A 230

LED

7,5W

warm WHITE

790lm



ACCU

Li-ion

2200mAh



IP44



9 008606 298037



Ø 175

H 210

A 230

901077 PANTETE

solar light; plastic, black / plastic, white
Solarleuchte; Kunststoff, schwarz / Kunststoff, weiss
luminaire solaire; plastique, noir / plastique, blanc

H 650, Ø 175

LED

7,5W

warm WHITE

830lm



ACCU

Li-ion

2200mAh



IP44



9 008606 298044



Ø 175

H 650

901078 PANTETE

solar light; plastic, black / plastic, white
Solarleuchte; Kunststoff, schwarz / Kunststoff, weiss
luminaire solaire; plastique, noir / plastique, blanc

H 1150, Ø 175

LED

7,5W

warm WHITE

840lm



ACCU

Li-ion

2200mAh



IP44



9 008606 298051



Ø 175

H 1150



900245



90°, 6 m

SAFETY & COMFORT



901082



120°, 5 m

SAFETY & COMFORT



901082 SPIANTE

solar light; plastic, black / plastic, white
Solarleuchte; Kunststoff, schwarz / Kunststoff, weiss
luminaire solaire; plastique, noir / plastique, blanc

L 140, H 140, A 140

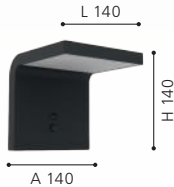

900245 BARACCONI

wall light; aluminium, plastic, black / plastic, transparent
Wandleuchte; Alu, Kunststoff, schwarz / Kunststoff, transparent
Applique; aluminium, plastique, noir / plastique, transparent

L 90, H 200, A 200



900246 BARACCONI

floor light; aluminium, plastic, black / plastic, satin finish
Stehleuchte; Alu, Kunststoff, schwarz / Kunststoff, satiniert
lampadaire; aluminium, plastique, noir / plastique, satiné

L 90, B 200, H 800





900246

LED



90°, 6 m

**SAFETY &
COMFORT**



48968



SAFETY & COMFORT



98191

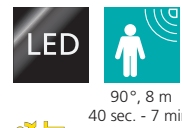

SAFETY & COMFORT



901081



SAFETY & COMFORT



*except/ außer/ except 98191

48968 UTRERA

solar light; plastic, black / plastic, white
Solarleuchte; Kunststoff, schwarz / Kunststoff, weiss
luminaire solaire; plastique, noir / plastique, blanc

L 200, B 90, H 120

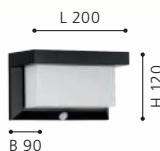
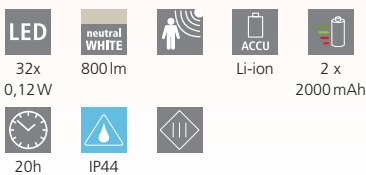

901081 CROARA

solar light; plastic, anthracite / plastic, white
Solarleuchte; Kunststoff, anthrazit / Kunststoff, weiss
luminaire solaire; plastique, gris anthracite / plastique, blanc

L 150, H 110, A 110

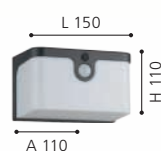
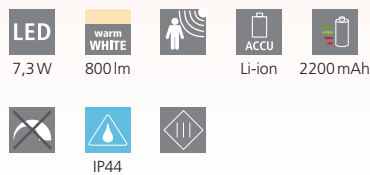

98191 PASTION

wall light; plastic, black
Wandleuchte; Kunststoff, schwarz
Applique; plastique, noir

L 180, H 120, A 130

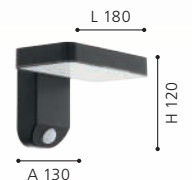
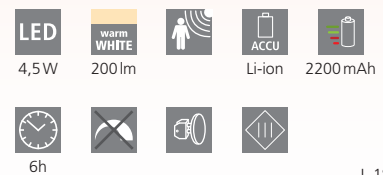

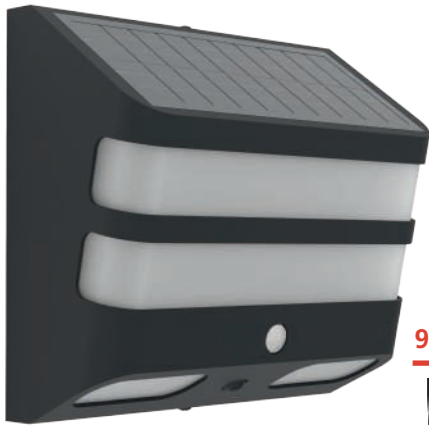

901084



120°, 5 m

SAFETY & COMFORT

901083

LED



120°, 5 m

SAFETY & COMFORT



901084 STIAPPA

solar light; plastic, black / plastic, white
Solarleuchte; Kunststoff, schwarz / Kunststoff, weiss
luminaire solaire; plastique, noir / plastique, blanc

L 120, H 200, A 80



6W



800lm



Li-ion



2200mAh



IP44

L 120



H 200

A 80



9 008606 297924

901083 SUZZARA

solar light; plastic, black / plastic, white
Solarleuchte; Kunststoff, schwarz / Kunststoff, weiss
luminaire solaire; plastique, noir / plastique, blanc

L 140, H 250, A 140



6W



800lm



Li-ion



2200mAh



IP44

L 140



H 250

A 140



9 008606 297917

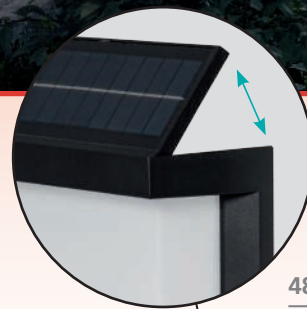

48968, 901083

The solar panel on the item is foldable.

Das Solarpanel am Artikel ist klappbar.

Le panneau solaire sur l'article est pliable.





98757



120°, 6 m
18 sec. - 25 sec.

SAFETY & COMFORT



48944



120°, 5 m

SAFETY & COMFORT



900255



120°, 6 m
18 sec. - 25 sec.

SAFETY & COMFORT

98757 LAMOZZO

wall light; plastic, white / plastic, transparent
Wandleuchte; Kunststoff, weiss / Kunststoff, transparent
Applique; plastique, blanc / plastique, transparent

L 140, H 210, A 110



3,2W 440lm Li-ion



2000mAh 6h IP54



9 002759 987572



900255 LAMOZZO

wall light; plastic, black / plastic, transparent
Wandleuchte; Kunststoff, schwarz / Kunststoff, transparent
Applique; plastique, noir / plastique, transparent

L 140, H 210, A 110



3,2W 440lm Li-ion



2000mAh 6h IP54



9 008606 231287



48944 PORRASSA

solar light; plastic, black / plastic, white
Solarleuchte; Kunststoff, schwarz / Kunststoff, weiss
luminaire solaire; plastique, noir / plastique, blanc

L 155, H 75, A 100



40x 0,5W 800lm Li-ion 2000mAh



6 - 8h IP44



9 002759 489441





901069

LED

901069 SAMBUCO

solar light; plastic, black
 Solarleuchte; Kunststoff, schwarz
 luminaire solaire; plastique, noir

L 175, B 100, H 375

LED

3W



RGB+WW
230lm



CONTROL
UNIT

Remote



IP44





* except/außer/except 98187, 98195, 98196

901085 PANETTIERI

solar light; plastic, black / plastic, white
Solarleuchte; Kunststoff, schwarz / Kunststoff, weiss
luminaire solaire; plastique, noir / plastique, blanc

L 145, H 170, A 30

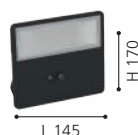
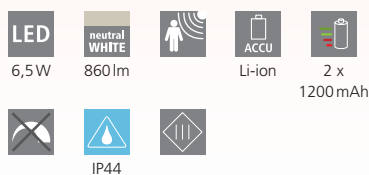

901086 PANETTIERI

solar light; plastic, black / plastic, white
Solarleuchte; Kunststoff, schwarz / Kunststoff, weiss
luminaire solaire; plastique, noir / plastique, blanc

L 145, H 170, A 30

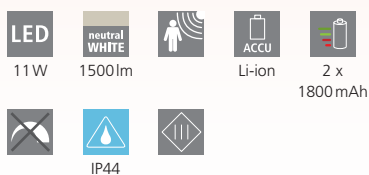

900247 VILLAGRAPPA

solar light; steel, plastic, black
Solarleuchte; Stahl, Kunststoff, schwarz
luminaire solaire; acier, plastique, noir

L 150, B 80, H 160

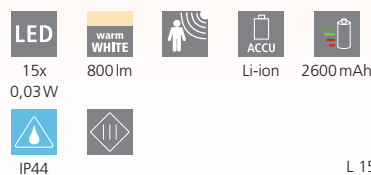



98195



140°, 9 m
3 sec. - 7 min.

**SAFETY &
COMFORT**



98187



90°, 8 m
30 sec. -

**SAFETY &
COMFORT**



98196



140°, 9 m
3 sec. - 7 min.

**SAFETY &
COMFORT**

98195 CASABAS

wall light; plastic, black / plastic, white
Wandleuchte; Kunststoff, schwarz / Kunststoff, weiss
Applique; plastique, noir / plastique, blanc

L 115, H 155, A 130



5W



470lm



Li-ion



1800mAh



IP44



9 002759 981952



98196 CASABAS

wall light; plastic, white / plastic, white
Wandleuchte; Kunststoff, weiss / Kunststoff, weiss
Applique; plastique, blanc / plastique, blanc

L 115, H 155, A 130



5W



470lm



Li-ion



1800mAh



IP44



9 002759 981969



98187 PALIZZI

wall light; plastic, black / plastic, transparent
Wandleuchte; Kunststoff, schwarz / Kunststoff, transparent
Applique; plastique, noir / plastique, transparent

L 155, H 145, A 110



2W



150lm



AA,
Ni-Mh



3 x
600mAh



IP44



9 002759 981877



HOW TO READ

ERKLÄRUNG

COMMENT LIRE

SENSOR INCLUDED
SENSOR INKLUDIERT
SENSOR INCLUS

This symbol indicates luminaires with a sensor. In addition to the Detection angle, Reach, Time setting (min./max.) and Response brightness (lx) is indicated.

Ist die Leuchte mit einem Sensor ausgestattet, wird dies durch ein Sensorsymbol gekennzeichnet. Zusätzlich werden Erfassungswinkel, Reichweite, Zeiteinstellung (max./min.) und die Ansprechhelligkeit (lx) angegeben.

Un produit avec cette symbole ont une détecteur de mouvement. Aussi le angle de détection, la minuterie et Luminosité de déclenchement (lx) sont indiqués.

900137
90° - 6 m
10 sec. - 12 min.
SAFETY & COMFORT

900138

900139

900137 ALAMONTE 3
wall light; aluminium, steel, black
Wandleuchte; Alu, Stahl, schwarz
Applique; aluminium, acier, noir

900138 ALAMONTE 3
pedestal light; aluminium, steel, black
Sockelleuchte; Alu, Stahl, schwarz
luminaire pour socle; aluminium, acier, noir

900139 ALAMONTE 3
floor light; aluminium, steel, black
Stehleuchte; Alu, Stahl, schwarz
lampadaire; aluminium, acier, noir

L 170, H 295, A 100
E27 1x 60W IP44

L 150, B 150, H 450
E27 1x 60W IP44

L 150, B 150, H 1000
E27 1x 60W IP44

9 008606 230112

9 008606 230129

9 008606 230136

TIMELESS
86

SERIES NAME
SERIENNAME
NOM DE LA SÉRIE

ARTICLE NUMBER
ARTIKELNUMMER
NUMÉRO D'ARTICLE

DESCRIPTION
BESCHREIBUNG
DESCRIPTION

The product description is composed as follows:
luminaire type; enclosure material, enclosure colour / glass or shade material, glass or shade colour

Die Produktbeschreibung setzt sich wie folgt zusammen:
Leuchtenart; Gehäusematerial, Gehäusefarbe / Schirm- bzw. Glasmaterial, Schirm- bzw. Glasfarbe

La description du produit est composée comme suit:
type de luminaire; matériel de boîtier, couleur de boîtier / matériel de verre ou abat-jour, couleur de verre ou abat-jour

DIMENSIONS
DIMENSIONEN
DIMENSIONS

all dimensions in mm | alle Größen in mm | toutes dimensions en mm

L = length | Länge | longueur

B = width | Breite | largeur

H = height | Höhe | hauteur

Ø = diameter | Durchmesser | diamètre

A = projection length | Ausladung | amplitude

ET = installation depth | Einbautiefe | profondeur utile

Base = base dimensions | Sockelmaße | dimensions de base

Attention! The dimensions relate solely to the sizes of the luminaire.
Any air spaces that would be relevant for a safe operating of the lamp were not considered.

Achtung! Die Größen beziehen sich nur auf die Abmessungen der Leuchte. Etwaige Lufträume, die für einen sicheren Betrieb der Leuchte notwendig sind, werden nicht berücksichtigt.

Attention! Les dimensions se réfèrent à la taille de la lampe seulement. Espacements éventuels, que seraient importants pour une opération de la lampe sans danger, n'ont pas été considérés.

SKETCHES
SKIZZEN
CROQUIS

The sketches state the most meaningful dimensions. If a product is adjustable by will, a turquoise arrow marks this function and only the maximum dimensions are indicated.

Die Bemaßung der Skizzen umfasst jeweils die aussagekräftigsten Größen. Bei verstellbaren Produkten kennzeichnet ein türkiser Pfeil diese Funktion und nur die maximalen Größen werden angegeben.

Les dimensions des croquis comprennent les plus représentatives. Si un produit est réglable au choix, une flèche turquoise affiche cette fonction et rien que les dimensions maximales sont indiquées.

PRODUCT IN THE AMBIANCE
PRODUKTE IM AMBIENTE
PRODUITS DANS L'AMBIENCE

You can find the article number next to each product in the ambiance pictures.

Sie finden die Artikelnummer neben jeder Abbildung des Produktes auf unseren Ambientebildern.

Vous pouvez trouver le numéro d'article à côté de chaque produit dans les images de l'ambiance.



900136

900136 ALAMONTE 3

wall light; aluminium, steel, black
Wandleuchte; Alu, Stahl, schwarz
Applique; aluminium, acier, noir

L 170, H 260, A 100

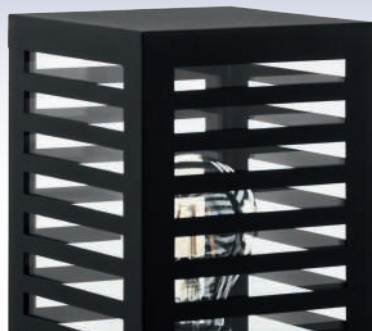

TIMELESS
87

PICTOGRAMMES
PIKTOGRAMME
PICTOGRAMMES

Technical details are represented as pictograms. An overview over all pictograms can be found on the next pages.

Technische Details werden als Piktogramme dargestellt. Eine Übersicht über alle Piktogramme finden Sie auf den nächsten Seiten.

Les détails techniques sont représentés sous forme de pictogrammes. Vous trouverez un aperçu de tous les pictogrammes dans les pages suivantes.

ENERGY EFFICIENCY LABELS
ENERGIEEFFIZIENZ-LABEL
LABEL DE L'EFFICACITÉ ÉNERGÉTIQUE

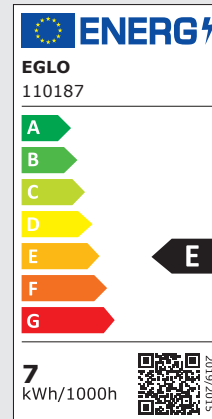

The new energy label must be indicated on all light sources with a luminous flux between 60 and 82,000 lumens and OLED. This applies to lamps, LED modules and luminaires where the light source cannot be removed without destroying it.

Das neue Energielabel muss auf allen Lichtquellen mit einem Lichtstrom zwischen 60 und 82.000 Lumen und OLED angegeben werden. Dies gilt für Lampen, LED-Module und Leuchten, bei denen die Lichtquelle nicht zerstörungsfrei entnommen werden kann.

Le nouveau label énergétique doit être indiqué sur toutes les sources lumineuses dont le flux lumineux est compris entre 60 et 82 000 lumens et sur les OLED. Cela s'applique aux lampes, aux modules LED et aux luminaires dont la source lumineuse ne peut être retirée sans être détruite.

The information on the label includes: / Die Angaben auf dem Etikett beinhalten: / Les informations figurant sur l'étiquette sont les suivantes :

- › Name/Trademark
Name/Warenzeichen
Nom/marque de commerce
- › Model / Modell / Modèle
- › Energy label scale A-G / Energielabel-Skala A-G / Échelle d'étiquetage énergétique A-G
- › Energy consumption for 1,000 hours of use/
Energieverbrauch bei 1.000 Stunden Nutzung/
Consommation d'énergie pour 1 000 heures d'utilisation
- › Energy efficiency class of the product/
Energieeffizienzklasse des Produkts/
Classe d'efficacité énergétique du produit
- › QR Code to EPREL (Product Database of the European Product Registry for Energylabelling)/
QR Code zur EPREL (Produktdatenbank der European Product Registry for Energylabelling)/
Code QR pour EPREL (base de données des produits du registre européen des produits pour l'étiquetage énergétique)

The energy spectrum ranges from G to A.
Das Energiespektrum reicht von G bis A.
Le spectre énergétique va de G à A.

EGLO WORLDWIDE – SALES COMPANIES

EGLO WELTWEIT – VERTRIEBSGESELLSCHAFTEN

EGLO WORLDWIDE – SOCIÉTÉS DE VENTE



AUSTRIA

EGLO LEUCHTEN GMBH

Heiligkreuz 22
6136 Pill
T: +43 5242 6996 110 | F: +43 5242 6996 972
info-austria@eglo.com



CHILE

EGLO CHILE ILUMINACIÓN LTDA.

Av. Américo Vespucio Norte 1930
Conchalí - Santiago de Chile
T: +562 2 595 2222
info-chile@eglo.com



DENMARK

EGLO DANMARK A/S

Agerbakken 20
8362 Hørning
T: +45 70 22 55 11
info-denmark@eglo.com



AUSTRALIA

EGLO LIGHTING AUSTRALIA

5/339 Archerfield Road
4077 Richlands | Queensland
T: +61 7 3375 1413 | F: +61 7 3375 1412
info@eglolighting.com.au



CHINA

DONGGUAN EGLO LIGHTING
COMMERCIAL CO LTD

No.1 | Shangqiao Industrial Rd Shangqiao, Dongcheng
Dongguancity, Guanzhouprovince
T: +86 769 2203 3866 | F: +86 769 2203 6866
info-china@eglo.com



ESTONIA

MOODNE VALGUSTUS AS

Rävala pst. 7
10143 Tallinn
T: +372 667 6670 | F: +372 631 3195
info-estonia@eglo.com



BELGIUM

EGLO BELGIUM BV

Antwerpsesteenweg 247
2950 Kapellen
T: +32 3 250 60 80 | F: +32 3 219 80 67
info-belgium@eglo.com



COLOMBIA

EGLO COLOMBIA ILUMINACIÓN SAS

Autopista Norte 800 Mts adelante del Peaje de los Andes
Costado Oriental Km 19 Lote 30
Bogotá - Chia
T: +57 (1) 744 2339
info-colombia@eglo.com



FINLAND

EGLO FINLAND OY

Malmin raitti 17A
00700 Helsinki
T: +358 20 7649 820
info-finland@eglo.com



BOSNIA AND HERZEGOVINA

EGLO RASVIJETA BH D.O.O.

Hrgovi Donji 178
76250 Gradacac
T: +387 35 86 85 00 | F: +387 35 82 44 41
info-Bosnia-Herzegovina@eglo.com | info@eglo.ba



COSTA RICA

EGLO COSTA RICA

Centro Comercial Calle Real local #8 de la sucursal del
BAC San José 800 metros al norte Guachipilín de Escazú
San José, Costa Rica
T: +506-2289-4690 | F: +506-2100-6384
info-costarica@eglo.com



FRANCE

EGLO FRANCE LUMINAIRE SARL

Z.A. Jeune Bois | 2 Rue de la Martinique
68274 Wittenheim
T: +33 3 89 62 50 45 | F: +33 389 6250 49
info-france@eglo.com



BULGARIA

EGLO BULGARIA EOOD

Main Road Burgas-Sofia | 5th kilometer | Building EGLO
8000 Burgas
T: +359 888 755 509
info-bulgaria@eglo.com



CROATIA

EGLO RASVIJETA D.O.O.

Jadranska avenija 9
10020 Zagreb
T: +385 1 379 40 62 | F: +385 1 379 41 04
info-croatia@eglo.com



GERMANY

EGLO LEUCHTEN HANDELS GMBH

Kleinbahnstr. 35
59759 Arnsberg
T: +49 2932 6269 0 | F: +49 2932 6269 39
info-germany@eglo.com



CANADA

EGLO CANADA INC.

20700 Route Transcanadienne
H9X 4B7 Baie D'Ufré, Quebec
T: +1 514 457 5483 | F: +1 514 457 5487
info-canada@eglo.com



CZECH REPUBLIC

EGLO CZ+SK s.r.o.

Náhodská 2479/63
193 00 Praha 9
T: +420 281 924 163 | F: +420 281 925 205
info-czechrepublic@eglo.com



GREAT BRITAIN AND IRELAND

EGLO UK LTD.

54 Denington Rd, Denington Industrial Estate
Wellingborough NN8 2QH, UK
T: +44 1604 790 986
info-UK@eglo.com

**GREECE**

EGLO HELLAS A.E.

Sykias 2 and parodos dekeleias
13679 Acharnai
T: +30 21 0800 2363
info-greece@eglo.com

**HUNGARY**

EGLO LUX KFT.

Fő út 143/A
2120 Dunakeszi
T: +36 27 341 353
info-hungary@eglo.com

**INDIA**

EGLO INDIA PRIVATE LIMITED

A-307, Ansal Chambers - 1, 3, Bhikaji Cama Place,
110066 Delhi
T: +91 85279 44288
info-india@eglo.com

**ITALY**

EGLO ITALIANA S.R.L.

Via Giotto, 4
31021 Mogliano Veneto (TV)
T: +39 041 45 66 245 | F: +39 041 45 74 066 / 071
info-italy@eglo.com

**KAZAKHSTAN**

EGLO KAZAKHSTAN LLP

Al-Farabi Avenue 7, Office 72, 14rd floor, Block 4A,
Nurly-Tau Business Center
50059 Almaty
T: +7 727 293 25 20 | M: +7 701 031 00 00
info-kazakhstan@eglo.com

**KOSOVO**

EGLO KOSOVA LLC

Lugisht e qytetit pn
20000 Prizren
T: +383 44 216 687 | SHOP: +383 49 699 100
info-kosovo@eglo.com

**LATVIA**

MOODNE VALGUSTUS AS

Rāvala pst.7
10143 Tallinn
T: +370 652 49923 | T: +372 667 6670
info-latvia@eglo.com

**LITHUANIA**

MOODNE VALGUSTUS AS

Rāvala pst.7
10143 Tallinn
T: +370 652 49923 | T: +372 667 6670
info-lithuania@eglo.com

**MALAYSIA**

EGLO ASIA SDN BHD

B-07-13, Empire Soho, Empire Subang, Jalan SS 16/1,
47500 Subang Jaya, Selangor Darul Ehsan.
T: +60162115313
info-malaysia@eglo.com

**MEXICO**

EGLO MÉXICO ILUMINACIÓN S DE RL DE CV

Prolongación Avenida López Mateos Sur N°3561,
Fraccionamiento Los Gavilanes
C.P. 45645 Tlajomulco de Zúñiga | Jalisco
T: +52 33 3687 20 95
info-mexico@eglo.com

**MIDDLE EAST**

EGLO LIGHTING MIDDLE EAST FZE

P.O. BOX 262073, LOB6, OFFICE G18
Jebel Ali, Dubai, UAE
T: +97 148810080 | F: +97 148810081
gulf@eglo.com

**MOROCCO - EGLO AFRICA**

EGLO MAGHREB LUMINAIRES SARL

219 Bd Med Zerktoni. Suite: 67
20230 Casablanca
T: +212 522 98 80 25 / -05
info-global@eglo.com | info.africa@eglo.com

**THE NETHERLANDS**

EGLO VERLICHTING NEDERLAND B.V.

Innovatiepark 20
4906 AA Oosterhout (NB)
T: +31 162 48 28 30
info-nl@eglo.com

**NORWAY**

MS BELYSNING

Gardermovegen 95B
2030 Nannestad
T: +47 63 888500 | F: +47 63 888501
info-norway@eglo.com

**PERU**

EGLO PERU S.A.C

Av Primavera 1419
Distrito de Santiago de Surco y Departamento de Lima
T: +51 902 763 635
info-peru@eglo.com

**POLAND**

EGLO POLSKA SP. Z O.O.

Ul. Dżwiękowa 2
02-857 Warszawa
T: +48 22 644 57 55 | T: +48 22 644 89 82
info-poland@eglo.com

**PORTUGAL**

EGLO PORTUGAL ILUMINAÇÃO, LDA

Rua Fonte Parada, 125
4595-434 Seroa-Paços de Ferreira
T: +351 255 890 000
info-portugal@eglo.com

**ROMANIA**

EGLO ROMANIA PRODEXIM SRL.

Str. Atomistilor nr. 1D
77125 Magurele - Ilfov
T: +40 314 250 902 | F: +40 314 250 899
info-romania@eglo.com

**RUSSIA**

EGLO LIGHTING LLC

Varshavskoe shosse 3 | Office 23
117105 Moscow
T: +7495 789 4311 | F: +7495 789 4312
info-russia@eglo.com

**SERBIA**

EGLO RASVETA DOO

Stefana Prvovenčanog 28
11000 Beograd
T: +381 11 3981 366 | F: +381 11 3981 389
info-serbia@eglo.com

**SLOVAKIA**

EGLO CZ+SK s.r.o

Náchodská 2479/63
193 00 Praha 9
T: +421 313 211 551 | F: +421 313 211 556
info-slovakia@eglo.com

**SLOVENIA**

EGLO RASVJETA D.O.O.

Jadranska avenija 9
10020 Zagreb
T: +386 158 093 18
info-slovenia@eglo.com

**SPAIN**

EGLO ESPANA ILUMINACIÓN S.L.

Avda. de Castilla,1 (Edif. Best Point) 2º Planta - Oficina
16A-B
28830 San Fernando de Henares, Madrid
T: +34 91 677 90 44 | F: +34 91 677 03 04
info-spain@eglo.com

**SWEDEN**

EGLO SVRIGE AB

Star Street 1
512 50 Svenljunga
T: +46 340 623 505
info-sweden@eglo.com

**SWITZERLAND**

EGLO SCHWEIZ AG

Seetalstrasse 142
6032 Emmen
T: +41 41 268 69 59
info-switzerland@eglo.com

**TURKEY**

EGLO Aydınlatma ithalat ihracat Ltd. Şti.

Eyüp Sultan Mah. Sekmen Cad. No:18/2
34885 Sancaktepe / Istanbul Samandıra
T: +90 216 311 09 -02 / -03 / -04 |
F: +90 216 311 09 / -05
info-turkey@eglo.com

**UKRAINE**

EGLO UKRAINE LTD

Vatlava Gavela boulevard, 6/7-A,
03124 Kyiv
T: +38 067 670 58 61
info-ukraina@eglo.com

**USA**



















EGLO USA, INC.

3640 Royal South Parkway
30349 Atlanta, Georgia
T: +1 404 477 5601 | F: +1 404 393 7053
info-usa@eglo.com









































LEGEND

PICTOGRAM / PIKTOGRAMME / PICTOGRAMME

SOCKETS FASSUNGEN DOUILLES

 LED	 G4	 G53
 2G7	 G5	 GU5,3 / MR16
 2G11	 G9	 GU10
 2GX13	 G10Q	 GX53
 E14	 G13	 GY6,35
 E27	 G23	 R7s

BULBS LEUCHTMITTEL AMPOULES

 E14 / C35	 E27 / A65 LED	 G4 / T9
 E14 / C35f	 E27 / A75 Filament	 G4 / LT9
 E14 / D45	 E27 / G45 LED	 G4 / LT14
 E14 / C35f LED	 E27 / G45 Filament	 G9
 E14 / T22	 E27 / G80 Filament	 G9 LED
 E14 / C35 Filament	 E27 / G95	 GU10
 E14 / C37 Filament	 E27 / G95 Filament	 GU10 LED
 E14 / C35f Filament	 E27 / G125	 GU10 SMD LED
 E14 / C37f Filament	 E27 / G95 LED	 GX53 / LF75
 E14 / P45 LED	 E27 / G200 Filament	LED LED board / LED Platine / LED bord
 E14 / P45 Filament	 E27 / R63 LED	 MR16
 E14 / P50	 E27 / ST48 Filament	 MR16 LED
 E14 / ST48 Filament	 E27 / ST64 Filament	 R7s / 78mm
 E14 / ST64 Filament	 E27 / B80 Filament	 R7s / 118mm
 E14 / T20 LED	 E27 / BR150 Filament	 R7s / 78mm LED
 E27 / A60	 E27 / DP165 Filament	 R7s / 118mm LED
 E27 / G90	 E27 / E140 Filament	
 E27 / QR63	 E27 / PS160 Filament	
 E27 / A60 LED	 E27 / T30 Filament	
 E27 / A60 Filament	 E27 / T32 Filament	

LIGHT COLOUR & LUMEN
LICHTFARBE & LUMEN
COULEUR LUMINEUX & LUMEN

The colours of the LED are represented as pictogrammes (see below), their luminous flux directly beneath. The luminous flux is quoted in lumen and describes the amount of light generated by the LED. The higher the value, the brighter is the lamp. Lumens are LED boards and are the light measurement value in bulbs.

Die Farben der LED werden als Piktogramm (siehe unten) dargestellt, deren Lichtstrom direkt darunter. Der Lichtstrom wird in Lumen gemessen und gibt die erzeugte Lichtmenge der LED an. Je höher der Wert, desto heller das Produkt. Lichtstromangaben (Lumen) sind Platinen- bzw. Leuchtmittelwerte.

Les couleurs de LED ont représentés sous forme de pictogrammes, leur flux lumineux directement en dessous. L'unité de flux lumineux est le lumen et il mesure la quantité de lumière générée par les LED. Plus la valeur est élevée, plus la lampe est lumineuse. Les lumens sont l'unité de mesure de l'intensité lumineuse des ampoules et des panneaux led intégrés.

	RGB RGB RGB		RGB + tunable white RGB + tunable white RGB + tunable white
	RGB + white RGB + weiß RGB + blanc		tunable white tunable white tunable white
	RGB + warmwhite RGB + warmweiß RGB + blanc chaud		warm white warmweiß blanc chaud
	RGB + coldwhite RGB + kaltweiß RGB + blanc froid		cold white kaltweiß blanc froid
	RGB + neutralwhite RGB + neutralweiß RGB + blanc neutre		neutral white neutralweiß blanc neutre

SWITCHES & SENSORS
SCHALTER & SENSOREN
INTERRUPTEUR & CAPTEURS

	Incl. cable & plug Inkl. Kabel & Stecker Câble & connecteur inclus		Pedal switch Trittschalter Interrupteur à pied		Swedish plug Stecker Schweden Connecteur swede
	Internal dimmer Eingebauter Dimmer Variateur intégré		Cable switch Kabelschalter Interrupteur à câble		"Touch me" ON/OFF "Touch me" EIN/AUS "Touch me" ON/OFF
	Button switch Druckknopf Interrupteur de pression		Incl. cable & plug transformer Inkl. Kabel & Stecktransformator Câble & transformateur à prise		"Touch me" ON/OFF & dimm "Touch me" EIN/AUS & Dimmen "Touch me" ON/OFF & graduable
	Function switch Funktionsschalter Interrupteur fonction		Remote control Fernbedienung Télécommande		Pull switch Zugschalter Interrupteur à bascule
	Rocker switch Wippschalter Interrupteur à bascule		Day & Night Sensor Tag & Nacht Sensor Sensor jour & nuit		Timer - automatic on/off Zeitschaltuhr - automatisches Ein- & Ausschalten Minuterie - peut être éteint et allumé automatiquement
	Pedal dimmer Trittdimmer Variateur à pied		Sensor Sensor Sensor		

FUNKTIONS & COMFORT
FUNKTIONEN & KOMFORT
FONCTIONS & CONFORT

	Incl. battery Inkl. Akku Incl. pile		Cutout (in mm) Ausschnitt (in mm) Perçage du panneau (en mm)		Packaging / delivery unit Verpackungs- / Liefereinheit Unité d'emballage / de livraison
	Incl. battery Inkl. Batterie Incl. pile		Dimmable Dimmbar mit externen Dimmer Draduable		Shortable Kürzbar Réductible
	Battery specifications Batteriespezifikationen Spécifications des piles		Not dimmable Nicht dimmbar Ne pas graduable		Voltage Volt Voltage
	Beam angle Ausstrahlwinkel Angle de rayonnement		Can be operated via control unit Bedienbar über Steuergerät Peut être commandé par une unité de contrôle		Watt
	Corner mount possible Eckmontage möglich Montage en coin possible		Replaceable LED Austauschbare LED LED remplaçables		USB connection USB-Anschluss Connexion USB
	Colour Rendering Index		Loadable in kg Belastbar in kg Chargeable en kg		Qi-Charger

PROTECTION CLASS
SCHUTZKLASSE
CLASSE DE PROTECTION

The protection class indicates to what extent the lamp is protected against electric shock. All lamps in this catalogue are at least protected with the protection class 1 - a higher class is specified in the information box of the respective lamp.

Die Schutzklasse gibt an, inwiefern ein Produkt gegen einen elektrischen Schlag gesichert ist. Alle Leuchten in diesem Katalog sind mit mindestens Schutzklasse 1 gesichert, bei höheren Klassen wird das Symbol im Infokasten der Leuchte angegeben.

La classe de protection indique, dans quelle mesure la lampe est protégée contre les chocs électriques. Tous les lampes dans ce catalogue sont protégées au moins avec la classe 1 - une classe plus élevée est indiquée dans l'information de la lampe.

	Protection class 1: protective earthing Schutzklasse 1: Schutzerdung Classe de protection 1: prise de terre		Protection class 2: protective insulation Schutzklasse 2: Schutzisolation Classe de protection 2: double isolation ou renforcée		Protection class 3: protective low voltage Schutzklasse 3: Schutzkleinspannung Classe de protection 3: très basse tension de sécurité
--	---	--	---	--	---

PROTECTION RATING
SCHUTZGRAD
INDICE DE PROTECTION

The protection rating ensures the operational safety of luminaires. The first number specifies the extent of the protection against the ingress of foreign bodies; the second number identifies the humidity protection grade. All luminaires in this catalogue are at least protected with the rating IP20 - a higher rating is specified in the information box of the luminaire.

Der Schutzgrad gewährleistet die Betriebssicherheit von Leuchten. Die erste Ziffer des IP Grades beschreibt den Schutzbereich gegen das Eindringen von Fremdkörpern, die zweite Ziffer informiert über den Grad des Feuchtigkeitsschutzes. Alle Leuchten in diesem Katalog sind mit mindestens Schutzgrad IP20 gesichert, bei höheren Graden wird das Symbol im Infokasten der Leuchte angegeben.

L'indice de protection assure la sécurité opérationnelle des luminaires. Le premier chiffre indique à quel point la protection est efficace contre l'insertion de corps étrangers; le second chiffre indique quant à lui le degré de protection par rapport à l'humidité. Tous les luminaires dans ce catalogue sont protégés au moins avec l'indice IP20 - un indice plus élevé est indiqué dans l'information d'article.

	IP33		IP44		IP54		IP65		IP67
--	------	--	------	--	------	--	------	--	------

REGISTER

SERIES NAMES
SERIENNAMEN
NOME DE PRODUITS

name name nom	page seite page	name name nom	page seite page	name name nom	page seite page	name name nom	page seite page
AGOLADA	112	CHIAPPERA	56	HELSINKI	95-97	NEMA	185
ALAMONTE	88	CHINOA	71	HILBURN	154	NEMA 1	184
ALAMONTE 1	88-90	CISTIerna	117	HILBURN 1	154	NEMBRO	42
ALAMONTE 3	86-87	CISTIerna 2	117	IPHAS 2	102	NEVIANO	67
ALBACETE	158	CITY	138-139	IZZALINI	122	NINNARELLA	53
ALGHERA	222	CONNECT Z	24	JABAGA	121	NISIA	98
ALORIA	162-164	CONNECT-Z SENSOR	24	JORBA	118	NISIA-Z	28
ALTILIA	242	CONNECTOR BOX	205	KIBEA	77	NIVAROLO	54
ARGOLIS 2	102-103	CORBEZZOLA	240	LADUNARA	220	ONJA	178
ARGOLIS-Z	26	CORNALe	104	LAMEDO	198	PAGINO	182
ATOLLARI	116	COSTORIO	78	LAMOZZO	250	PALIZZI	253
AZZINANO	105	CROARA	248	LATERNA 4	172-173, 176	PALOSCO	50
BARACCONI	246	CUBA	208	LATERNA 5	174,177	PANETTIERI	252
BARROSELA	156	CUBONE	228	LESMO	127	PANTETE	245
BASALGO-Z	27	DESELLA 1	118	LIBISA	230	PARK	135
BELCREDA	71	DETECT ME 1	194, 197	LISIO	148-149	PARK 4	204-205
BEVERLY	108	DETECT ME 3	194, 197	LM_LED_E27	34, 202	PARK5	206
BITETTO	78	DETECT ME 5	195	LM_LED_GU10	34	PARTAJ	228
BOSARO	109	DETECT ME 6	194, 197	MADRIZ	106	PASTION	248
BOTTONA	222	DONATORI	144	MANFRIA	42	PERNATE	55
BOVOLONE	160	DONINNI 1	44-45	MANNERA	218-219	PICCOLA	213
BREGANZO	135	DREOLI	238	MARGO	201	PONENTE	214
BREGANZO 1	135	ENTRIMO	52	MARLIANO	241	PORRASSA	250
BRIANZA	76	EREMITANA	121	MARTANO	240	PRATA VECCHIA	100
BUDRONE	81	EREMITANA-Z	27	MARUGGIO	125	PREDAZZO	75
BUFALATA	78-79	FAEDO 3	186-193	MEGGIANO	217	PULFERO	152
CALDIERO	50	FAEDO 4	184-185	MELGOA	152, 156	PULFERO 1	158
CALPINO	126	FANDINA	60	MELZO	46	RAVELLO	58-59
CALPINO 2	126	FARINDOLA	74	MILTON	154, 156	REDONDO	68
CALPINO 3	128-129	FIUMICINO	48-49	MIRANDOLA	151	RIFORANO	40-41
CAMARDA	130-131	FLATNEON Z	32	MONREALE	161	RIGA	110-111
CANOVE	152	FLATNEONLED	232-233	MONTEROLLO SMOKE	226	RIGA 3	198
CARRARO	150	FORNACI	54	MONTEROLO	224-225	RIGA 5	114-115
CASABAS	253	FOSSOMBRONE	220	MONTEROLO-Z	30-31	RIGA-LED	112-113
CASAZZA	133	FROSOLONE	230	MORINO	68	ROBLEDO	109
CASCINETTA	90-91	FUSIGNANO	220	MULTI CHARGING PAD	215	RONCO	103
CERNO	136-137	GORZANO	75	MUSSOTTO	133	RUBIO	100
CERRISI	238	GRUTTI	120	NAVEDO	166-168, 170-171	SAKEDA	118

name name nom	page seite page	name name nom	page seite page
SALITTA	64-65	VERRES	133
SALLE	92	VIGNANELLO	227
SALVANESCO	106	VILLAGRAPPA	252
SAMBUCO	251	VILLAGRAZIA	70
SAN TELMO	159	ZIMBA	201
SELINUS	59	ZIMBA-LED	201
SERRICELLA	60		
SESIMBA 1	72		
SIDNEY	147		
SINGLE CHARGING PA	215		
SIRMIONE	146		
SITIA	77		
SONCINO	151		
SONELLA	104		
SORRONARO	76		
SPIANTE	246		
SPIAZZINA	75		
SPINETOLI 2	231		
SPONGANO	124		
STAGNONE	51		
STIAPPA	249		
STOCKHOLM 1	108		
SUZZARA	249		
TAPARITA	63		
TAVERNA	100-101		
TONEGO	113		
TORRECOLA	123		
TRECCATE	160		
TREVILOLO	72		
TRIBANO	136		
TRONO STICK	108		
TRONTO	199		
UGENTO	62-63		
USIGNI	241		
UTRERA	248		
VALDEO	158, 160		
VENTO 1	107		
VENTO 2	106		



REGISTER

ARTICLE NUMBER

ARTIKELNUMMER

NUMÉROS D'ARTICLE

Number nummer Numéro	page seite page	Number nummer Numéro	page seite page	Number nummer Numéro	page seite page	Number nummer Numéro	page seite page	Number nummer Numéro	page seite page	Number nummer Numéro	page seite page	Number nummer Numéro	page seite page
12251	34	88139	139	94105	111	97261	160	98195	253	900118	60	900272	30
12253	34	88142	138	94106	110	97284	136	98196	253	900119	60	900275	121
22144	176	88144	138	94107	110	97285	146	98266	44	900122	220	900276	121
22145	176	88152	208	94111	185	97287	146	98269	44	900123	220	900277	103
22462	174	88153	208	94121	107	97288	146	98271	44	900124	26	900278	102
22463	174	88489	154	94128	109	97289	104	98272	45	900125	26	900279	103
22464	174	88575	201	94138	135	97294	151	98273	88	900126	26	900281	102
22466	177	88744	208	94779	109	97296	160	98701	144	900131	27	900283	102
22467	172	89767	178	94788	90	97303	46	98702	144	900132	75	900284	117
22468	173	89768	178	94792	152	97304	46	98703	144	900133	60	900285	150
22469	173	90184	159	94803	112	97308	55	98705	106	900136	87	900286	150
22471	173	90748	204	94804	112	97312	71	98707	76	900137	86	900287	56
22472	176	91206	205	94831	88	97419	195	98709	71	900138	86	900288	81
22995	177	91207	205	94832	89	97421	197	98711	71	900139	86	900289	81
22996	177	92736	112	94833	90	97422	194	98713	90	900189	121	900291	78
30184	148	93095	164	94841	152	97451	50	98714	91	900201	226	900292	127
30185	148	93097	162	94843	154	97455	186	98715	91	900202	226	900294	222
30187	148	93098	162	94855	158	97456	186	98719	151	900203	226	900295	222
30188	149	93099	163	94858	156	97457	186	98721	58	900208	227	900296	222
30191	136	93254	77	94863	156	97458	187	98723	58	900209	227	900297	103
30192	137	93268	108	94866	154	97459	188	98724	59	900211	227	900299	230
30205	98	93318	68	94871	104	97461	188	98725	40	900212	230	900445	126
30206	98	93319	68	94872	104	97462	188	98726	41	900213	228	900457	218
30207	98	93368	68	95097	118	97463	189	98727	40	900215	228	900458	219
32898	115	93384	184	95235	201	97464	197	98728	40	900219	232	900459	219
32899	115	93385	184	95988	77	97465	194	98731	100	900221	232	900461	219
33152	190	93403	164	96013	108	97471	184	98738	50	900222	233	900669	78
33153	191	93407	162	96018	135	97632	46	98746	72	900223	232	900671	79
33154	190	93408	163	96021	72	98085	117	98747	72	900224	233	900672	59
33155	190	93426	205	96207	52	98086	117	98751	42	900238	228	900673	54
33156	192	93445	168	96239	160	98096	42	98757	250	900239	230	900674	54
33157	193	93447	168	96241	158	98097	42	99099	24	900243	240	900675	54
33158	192	93448	168	96256	118	98101	224	99106	24	900245	246	900676	67
33159	192	93452	170	96262	158	98102	225	99521	133	900246	246	900677	67
48944	250	93454	171	96276	116	98103	224	99565	137	900247	252	900678	67
48968	248	93456	166	96277	116	98104	225	99566	137	900255	250	900679	78
81751	96	93457	166	96287	118	98121	161	99567	139	900256	187	900681	63
81752	97	93458	166	96365	106	98123	161	99568	139	900257	189	900682	74
81753	96	93459	167	96452	197	98148	48	99569	114	900258	27	900684	59
82309	138	93462	167	96454	194	98149	48	99571	114	900259	220	900688	53
83278	96	93463	170	96505	113	98151	48	99572	100	900261	64	900689	53
83279	97	93464	170	97119	113	98152	49	99578	76	900262	65	900691	51
83281	97	93465	171	97146	50	98153	70	99584	106	900263	64	900692	51
83433	135	93481	198	97159	105	98154	70	99586	101	900264	64	900698	89
83589	156	93482	198	97218	133	98176	182	99587	88	900265	28	900709	62
83966	147	93994	75	97222	75	98178	182	99598	100	900266	28	900802	56
83971	147	94093	201	97226	152	98182	199	110186	202	900267	28	900803	56
86189	198	94101	111	97238	133	98185	185	110187	202	900268	30	900804	240
86541	108	94102	111	97241	126	98187	253	110189	202	900269	31	900805	240
87105	147	94103	110	97242	126	98191	248	900117	231	900271	30	900807	130

Number number Numéro	page seite page	Number number Numéro	page seite page
900808	130	901083	249
900809	130	901084	249
900811	131	901085	252
900885	124	901086	252
900886	124	901087	241
900887	124	901088	241
900888	125	901089	241
900889	125	901092	32
900891	125	901093	215
900923	213	901094	215
900924	213	901095	32
900925	213		
900978	217		
900979	217		
900981	217		
900982	214		
900983	214		
900984	214		
900985	95		
900986	95		
900987	95		
900992	63		
900993	63		
900995	122		
900996	122		
901025	120		
901026	120		
901028	123		
901029	123		
901031	206		
901032	206		
901033	92		
901034	92		
901035	92		
901063	129		
901064	128		
901065	129		
901066	129		
901069	251		
901071	238		
901072	238		
901073	242		
901074	242		
901075	242		
901076	245		
901077	245		
901078	245		
901079	238		
901081	248		
901082	246		



All previous catalogues and price lists are no longer valid with the issue of this catalogue. Errors, misprints, model and price changes and technical modifications are reserved. We deliver based on our terms of delivery and payment. Our products comply with the European light norm EN60598. Products with the ENEC test mark are conforming to the guide line 2006/95/EG. Products with additional safety remarks (e.g protection class, IP) are identified within the product family with the relevant symbol and number. The content of this catalogue is protected under copyright law for EGLO Leuchten GmbH. All rights reserved. Our specific written consent must be obtained before using any illustrations and texts. The pictures are 4C prints and may differ from the original.

The product pictures and ambiances in this catalogue can deviate from reality, and they do not necessarily concur with the usual application of the product. EGLO does not assume liability for the correctness, completeness or the application depiction of the products and/or the product information. Design, layout and composition: EGLO Leuchten GmbH, A-6136 Pill - AUSTRIA
Print: Gutenberg-Werbering GmbH, 4040 Linz - AUSTRIA
Pictures: EGLO, Star Trading, Adobe Stock, istockphoto.com

Mit diesem Katalog verlieren alle vorhergehenden Kataloge und Preislisten ihre Gültigkeit. Irrtümer, Druckfehler, Modell- und Preisänderungen sowie technische Änderungen vorbehalten. Wir liefern zu unseren Liefer- und Zahlungsbedingungen. Unsere Produkte entsprechen der europäischen Leuchtennorm EN 60598. Produkte mit dem ENEC Prüfzeichen sind konform mit der Richtlinie 2006/95/EG. Produkte mit weiteren Sicherheitshinweisen (zB. Schutzklasse, IP) sind mit Symbol und Zahl bei der Produktfamilie ausgezeichnet. Der Inhalt dieses Kataloges ist für die EGLO Leuchten GmbH urheberrechtlich geschützt. Alle Rechte sind vorbehalten. Bilder und Texte dürfen nicht ohne vorherige ausdrückliche, schriftliche Genehmigung verwendet werden. Die Abbildungen sind 4C Drucke und können vom Original abweichen.

Die Katalogbilder und die gezeigten Darstellungen der Produkte können von der Wirklichkeit abweichen und nicht den üblichen Produktanwendungen entsprechen. EGLO übernimmt keine Haftung für die Richtigkeit, Vollständigkeit und Anwendungsdarstellung der Produkte und Produktinformationen.

Gestaltung, Layout und Satz: EGLO Leuchten GmbH, A-6136 Pill - AUSTRIA
Druck: Gutenberg-Werbering GmbH, 4040 Linz - AUSTRIA
Bilder: EGLO, Star Trading, Adobe Stock, istockphoto.com

Le présent catalogue remplace tous les catalogues et tarifs précédents. Sous réserve d'erreurs, de fautes d'impression, de modification des modèles et de changement de prix et de technique. Nous livrons sur la base de nos conditions de livraison et de paiement. Nos produits sont conformes aux normes européennes EN 60598 et portent le marquage CE. Les produits portant la marque ENEC sont conformes à la Directive 2006/95/EG. Les produits portant d'autres indications de sécurité (par exemple classe de protection, IP) sont identifiés par le symbole et le nombre correspondants dans la famille de produits.

Le contenu du présent catalogue est protégé pour la société EGLO Leuchten GmbH par un copyright. Tous droits réservés. Toute reproduction d'images et du texte est interdite sans autorisation explicite par écrit préalable. Les images sont imprimées en 4C et peuvent différer de l'original.

Les images des produits et les ambiances dans le catalogue peuvent dévier de la réalité et ne sont pas nécessairement en ligne avec l'usage habituel du produit. EGLO n'engage pas sa responsabilité sur la justesse des images et sur les informations relatives à l'usage pouvant être fait des produits.

Conception, maquette et composition: EGLO Leuchten GmbH, A-6136 Pill - AUSTRIA
Presse: Gutenberg-Werbering GmbH, 4040 Linz - AUSTRIA
Images: EGLO, Star Trading, Adobe Stock, istockphoto.com

12-2023



EGLO Leuchten GmbH
Heiligkreuz 22
A-6136 Pill
Austria
Tel. +43 (0) 5242 6996
Fax +43 (0) 5242 6996-972
info@eglo.com
www.eglo.com

KATA24

my light | my style